

# FUNKTION-ONE

## X02, X04 & X04A OEM 4 SERIES USER MANUAL



**Funktion One Research Ltd**  
Hoyle, Horsham Road,  
Beare Green, Dorking  
RH5 4PS, UK

Phone : +44 (0)1306 712820  
Fax : +44 (0)1306 711240  
[www.funktion-one.com](http://www.funktion-one.com)

Designed and written by Waring Hayes 05/2006 (XTA)  
Ammended by Funktion One Research Ltd 11/2009  
If you have any comments or suggestions about this manual, please contact  
Funktion-One at the address above or email: [mail@funktion-one.com](mailto:mail@funktion-one.com)



© XTA Electronics Ltd 2006  
Front panel designs and OEM product names:  
© Funktion One Research Ltd 2008

# X04 Quick Reference

Editing channels: press channel's **EDIT** key. First press accesses that channel's gain. To scroll through channel's parameters, use the **BACK** and **NEXT** keys. Second press accesses last viewed parameter. Third press will drop back to the default screen.

Accessing menus: press the **MENU** key. Use the **BACK** and **NEXT** keys to select the sub-menu required, and enter the sub-menu using the **ENTER** key. This applies to all levels of menu. **ENTER** always confirms selections.

## The Menus and their Contents

**GLOBAL MEMORY** Sub-menu: Recall/Store/Eraser of Input and Crossover, Input only or Crossover only presets. Funktion One factory presets are stored as Crossover only presets

**INPUT SECTION** Sub-menu: Set up input ganging, and Reset Input parameters

**CROSSOVER** Sub-menu: Set up or adjust crossover design, including routing and auto limiter setting. Also set up output ganging.

**INTERFACE** Sub-menu: Comms interface setup (RS232 and RS485), G.P.I. interface configuration, and wireless interface.

**SYSTEM** Sub-menu: Used to view unit's status, and select various global options such as PEQ 'Q' or bandwidth units, delay units, and output metering point (pre/post mute).

**SECURITY** Sub-menu: Used for locking various operations of the unit, using a 4 digit code.

**AES/EBU** Sub-menu: Monitor AES input status info. (AES inputs are switched via rear panel.)

### Notes

The crossover (output) settings may be stored independently of the input settings, using the **Global Memory** sub-menu.

The output meters show level, in dB from the limiter threshold, and the input meters show level from clipping the A-D converters, pre-gain and all EQ.

The high and low pass crossover filters are defined independently on each output channel.

To access the limiter attack and release parameters, select "AutoLimiter TimeCst: No" when designing a crossover.

To swap parametric filter units between bandwidth ('BandW') and 'Q', enter **System** Sub-menu, select 'Filter Q / Bandwidth', and select required readout units.

To swap delay time units, enter **System** Sub-menu, select 'Delay Time / Distance', and select required readout units.

Pressing an **EDIT** key, flashes corresponding channels routed to / from that channel.

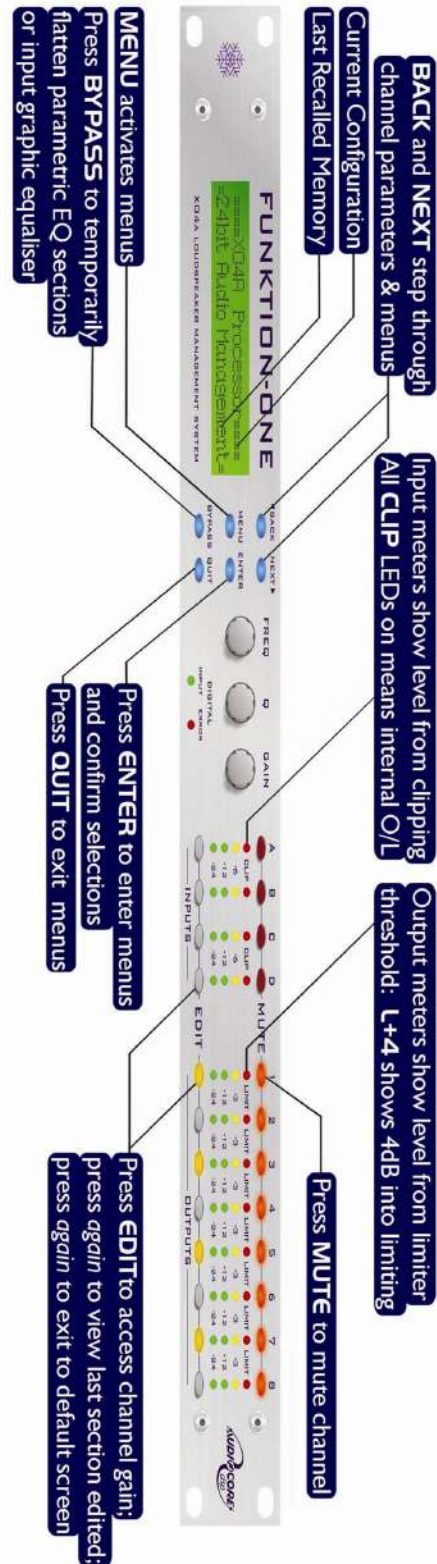

# Contents

<b>XO4 Quick Reference</b>	<b>2</b>
<b>Contents</b>	<b>3</b>
<b>Important Safety Information</b>	<b>5</b>
<b>Thanks</b>	<b>7</b>
<b>Unpacking the unit</b>	<b>7</b>
<b>Introduction</b>	<b>8</b>
<b>Introduction</b>	<b>8</b>
Features	8
Front Panel Familiarisation	10
<i>Rear Panel Connections</i>	11
<b>Operating the 4 Series</b>	<b>12</b>
Note about operation of XO4A with AudioCore software.	12
Start-up procedure	12
Preliminary Set-up	12
Routing Options and Processing Blocks	13
Input Channel Makeup	13
Output Channel Makeup	13
Preset Routing Configurations ( <b>XO4</b> shown)	13
Free Assign Routing	16
<b>Editing Audio Parameters – Input Channels</b>	<b>17</b>
Input Gain	17
Base Delay	17
Input Parametric EQ	17
<b>Editing Audio Parameters – Output Channels</b>	<b>18</b>
Output Gain	18
Output Polarity	18
Output Delay	18
Output High Pass Filter	19



Output Low Pass Filter	19
Output Parametric EQ	19
Output Limiter	20
Output "D-Max" (Clip) Limiter	20
<b>Input Ganging and Output Ganging</b>	<b>21</b>
<b>Menu System Overview</b>	<b>23</b>
<b>Menu System Shortcuts</b>	<b>24</b>
<b>Menus in Detail</b>	<b>25</b>
<b>Memory Structure</b>	<b>26</b>
<b>Preset Files and Loader Program</b>	<b>28</b>
<b>Remote Control Interface Operation</b>	<b>29</b>
RS232 Interface	29
RS232 Connection (Single Unit)	29
Loading New Software via a PC	30
RS232 Connection (Multiple Units)	30
Shadow ID Numbers	32
RS485 Connection	33
<b>AES Inputs</b>	<b>35</b>
AES Input	35
<b>AES Diagnostics and Status Information</b>	<b>36</b>
<b>Security and Locking</b>	<b>37</b>
Entering the Password to Complete the Locking Operation	37
Unlocking the Unit	38
Forgotten the Password?	38
Program Limiter and "D-Max" Limiter	39
<i>Program Limiter</i>	<i>39</i>
<i>"D-Max" Clip Limiter</i>	<i>40</i>
Setting Accurate Limiter Thresholds	42
The Funktion One Approach	43
<i>Balanced sound "On The Limit"</i>	<i>43</i>
<i>Digital Crossovers</i>	<i>44</i>
Crossover Filter Slopes	44
Time Alignment	45



<b>Parametric Filter Types and Their Uses</b>	<b>46</b>
<i>Standard Parametric EQ</i>	46
<i>Shelving EQ (High Shelf shown)</i>	46
<i>Shelving EQ (High Shelf shown)</i>	47
<i>Creating a Flat-topped EQ Response</i>	47
<i>Low/High Pass Variable 'Q' Filter (Low Pass shown)</i>	48
<b>Specifications</b>	<b>49</b>
<b>Warranty</b>	<b>50</b>
<b>Options and Accessories (available from XTA or via Funktion One)</b>	<b>50</b>
<b>Index</b>	<b>51</b>



An example of this equipment has been tested and found to comply with the following European and international Standards for Electromagnetic Compatibility and Electrical Safety:

Radiated Emissions (EU): EN55013-1 (1996)  
 RF Immunity (EU): EN55103-2 (1996) RF Immunity, ESD, Burst Transient, Surge, Dips & Dwells  
 Electrical Safety (EU): EN60065 (1993)

## Important Safety Information

Do not remove Covers.  
 No user serviceable parts inside, refer servicing to qualified service personnel.  
 This equipment must be earthed.



**CAUTION**  
 RISK OF ELECTRIC SHOCK  
 DO NOT OPEN  
 DO NOT EXPOSE TO RAIN, MOISTURE,  
 DRIPPING OR SPLASHING



**ATTENTION**  
 RISQUE DE CHOC ELECTRIQUE  
 NE PAS ENLEVER  
 NE PAS EXPOSER A LA PLUIE NI A L'HUMITE



Objects containing liquids, such as vases or drinks, must not be placed on this equipment.





## Thanks

---

Thank you for choosing a Funktion One OEM Audio Management System for your application, whether it is the XO2, XO4 or XO4A version. Please spend time reading through this manual, so that you obtain the best possible performance from the unit.

## Unpacking the unit

---

After unpacking the unit, please check it carefully for any damage. If any is found, immediately notify the carrier concerned - you, the consignee, must instigate any claim. Please retain all packaging in case of future re-shipment.

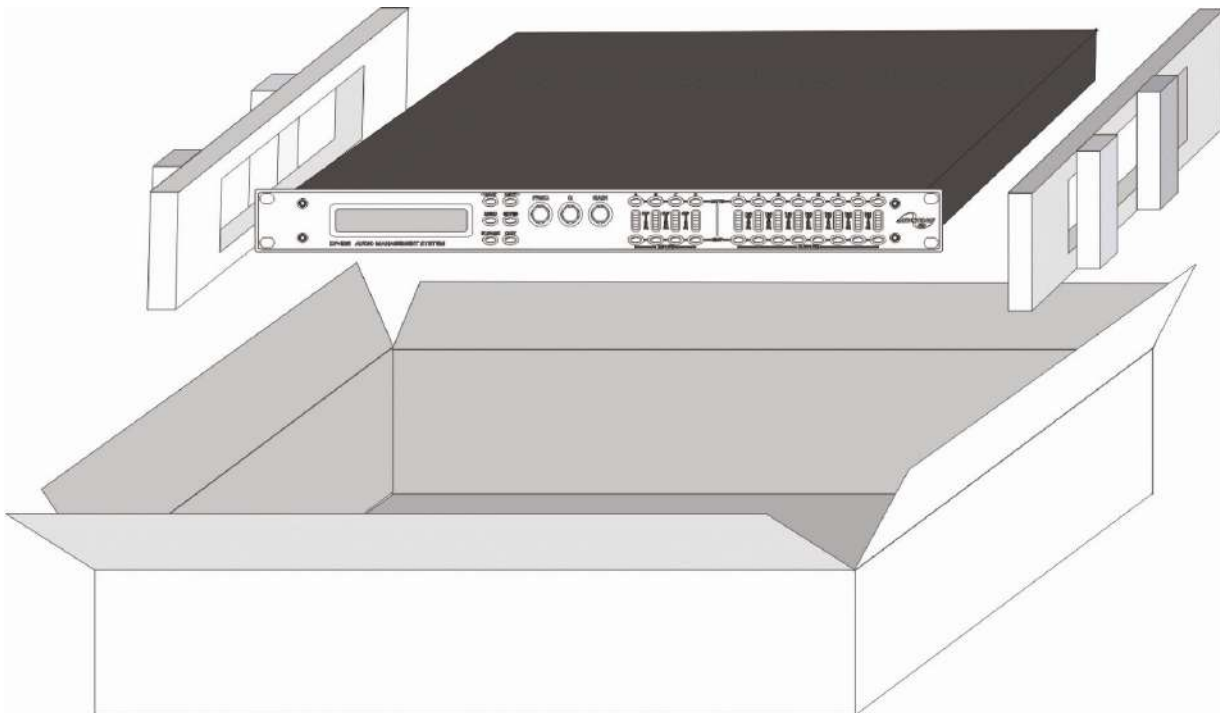

Please think of our environment and don't bin any materials, including this manual. When the product has reached the end of its useful life, please dispose of it responsibly through a recycling centre.



# Introduction

---

IMPORTANT: “4 Series” refers to all, **X02** (2-in 6-out), **X04** (4-in 8-out) and **X04A** (4-in 8-out, with AudioCore compatibility), Funktion One OEM products manufactured by XTA. These are all very similar in build and operation. This document tries to specify when certain features are available in which product. However, it is ultimately up to the reader to discern whether their product corresponds with certain parts of the text.

This document is mainly based around the **X04**. Where the document refers to RS232 and RS485 connectivity and AudioCore this is applicable to the **X04A only**.

The **4 Series** are powerful DSP based audio processors, ideally suited for install applications, where they combine the functions of a multitude of conventional products in a compact 1U unit with extensive remote control capabilities. To achieve this, the units have up to four inputs and eight outputs which can be configured in a selection of basic crossover modes – 4 x 2 way; 2 x 3 way + 2 Aux; 2 x 4 way; and 1 x 8 way (as applicable to i/o configurations). They also offer a “free assign” mode, which allows completely flexible routing of any output from any combination of inputs.

Each input has a gain control, variable delay and a further eight bands of fully parametric equalisation. The parametric filter bands have a selection of different filter types available.

Each output has a gain control, variable delay, high and low pass crossover filters, nine bands of fully parametric equalisation, polarity switching, a fully featured limiter and a final clip limiter. The crossover filters offer slopes of up to 48dB/Octave, with a variety of responses available.

Remote control<sup>1</sup> is catered for in the form of RS232 and RS485 ports, and multiple user memories are provided for the storage and recall of settings. A GPI interface may also be fitted to allow remote memory recalls using simple switch closure apparatus.

Security lock-out is available for all controls.

The **4 Series** are also equipped with AES/EBU digital inputs and include a sample rate converter, capable of accepting anything from 32kHz up to 192kHz.

The **X04A** may be controlled externally by XTA’s proprietary



Windows™ software, along with existing and future ‘AudioCore’ products.

## Features

Superb audio quality – carefully optimised double precision signal processing coupled with 24 bit conversion ensure a dynamic range in excess of 117dB. The high sampling rate of 96kHz means minimal filtering providing exceptional sonic purity with a bandwidth in excess of 32kHz.

A flexible input/output multi-mode format caters for any configuration, regardless of scale.

Both routing of inputs to outputs, and ganging (for editing) are completely flexible.

A completely new SHARC™ based DSP platform supplies phenomenal computational power, allowing the unit to provide multiple bands of standard parametric equalisation on every input and output. This additional power also permits both program limiters and no overshoot clip limiters on each output.

Delay of up to 650mS may be independently set for each output, with an exceptionally fine minimum increment of 300nS, which corresponds to a distance change of 0.1mm!

---

<sup>1</sup> Note that only the RS232 and RS485 interfaces offer full remote control of this product – the GPI interface may only be used for memory recall (program change) purposes.





## Front Panel Familiarisation



**LCD Screen:** Shows, by default, the name of the last recalled memory on the bottom line of the screen, and the current routing on the top line. It is also used to show all parameters as they are edited and all menu selections.

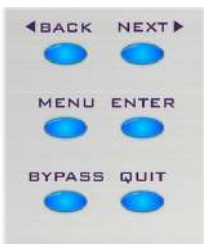

**Control Keys:** Selection and adjustment of parameters.

**NEXT** key moves forward through list of parameters.

**BACK** key moves backward through list of parameters.

**MENU** key activates the main menu – a second press selects the last menu edited – a third press selects the last menu item. In this way, three presses on **MENU** from the default screen will jump back to the last parameter adjusted. Selection of different menus is accomplished using the **BACK** and **NEXT** keys, or with the **FREQ** encoder.

**ENTER** key enters the chosen menu, confirms selections, and changes filter types when editing parametric sections.

**BYPASS** will flatten the currently selected parametric sections. Note that, for safety reasons, it is not possible to bypass the high and low pass filter sections.

**QUIT** exits menus back to the default screen.



**Rotary Encoders:** Three velocity sensitive encoders adjust the relevant parameters as displayed on the screen.

**Status LEDs:** The two status LEDs show, from left to right, AES inputs selected (flashing if not locked) and Error.

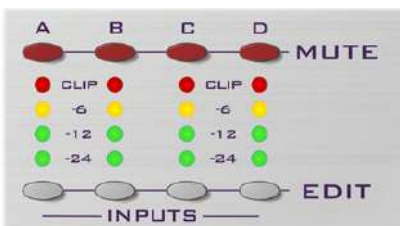

**Input Sections:** Control and monitor input signal paths.

Red **MUTE** buttons illuminate when pressed and mute the audio for that channel.

**EDIT** buttons illuminate yellow when pressed, and access gain on first press, then last viewed parameter on second press, then exit on third press.

Input meters show dB from clipping point of the analogue to digital converters. Yellow (**-6dB**) LED illuminates 6dB from clipping. Red **CLIP** LED may illuminate independently from the rest of the meter to show digital overflow. All four **CLIP** LEDs illuminating indicates internal clipping after the ADC.

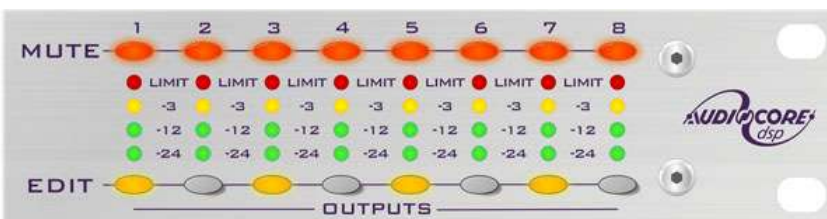

**Output Sections:** Control and monitor output signal paths.

Red **MUTE** buttons illuminate when pressed and mute the audio for that channel.

**EDIT** buttons illuminate yellow when pressed, and access gain on first press,

then last viewed parameter on second press, then exit on third press. Output meters show dB from limiting. The yellow LED illuminates at the onset of limiting. The red LED illuminates at 4dB into limiting (i.e. 4dB of gain reduction).



## Rear Panel Connections

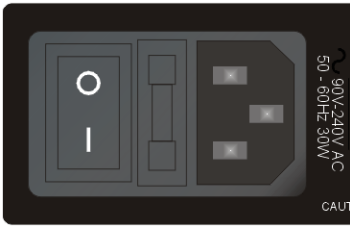

**Power Switch:** turns the unit's mains supply off and on.  
**Mains Fuse:** located in a finger-proof holder adjacent to the mains inlet. A spare fuse is also located in this holder.  
**Mains Inlet:** connected via a standard IEC socket.



**RS232:** RS232 standard via a 9 pin D-type connector, for connection to a PC. In **X04A** data is converted to RS485 standard and relayed to slave units via the RS485 sockets.  
**RS485 In-Out:** XLR sockets (**X04A**), used for transmission of remote control data over long distance or multiple unit applications. See pages 325-29 for more information.

For more details on interfaces see the Interface Guide, available from [www.xta.uk.com](http://www.xta.uk.com)

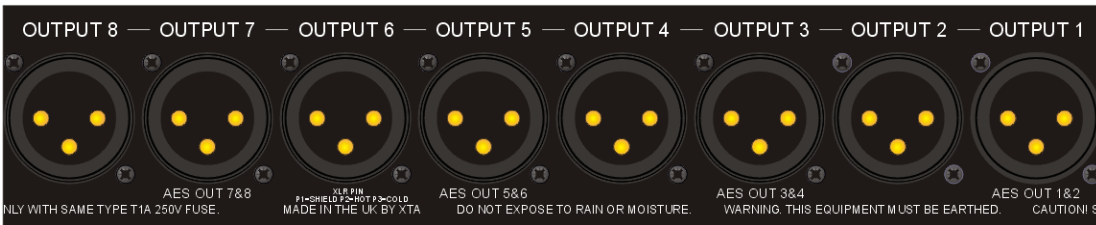

**Audio Outputs:** 3 pin XLR sockets are provided for each channel. All are fully balanced, pin 2 hot, 3 cold, 1 screen. Please note, AES Digital Outputs are not a function of the Funktion-One OEM 4 Series units.



**AES Input Switch:** Recessed switch to select AES digital inputs. Red LED will illuminate in the hole when AES inputs are selected, along with the corresponding front panel indicator.

**Audio Inputs:** 3 pin XLR sockets are provided for each channel. All are fully balanced, pin 2 hot, 3 cold, 1 screen.

Note the legending on the panel to designate which inputs are used for AES when the digital inputs are enabled. Please see page 350 for more information.

**xta ALERT** Always replace the fuse with the correct type and rating as shown on the rear panel legend.



# Operating the 4 Series

---

## Note about operation of XO4A with AudioCore software.

The following operating information covers setup and control of the **4 Series** via the front panel controls only. Please consult the manual supplied with this software for information regarding full computer control.

## Start-up procedure

Switching on the unit will display a brief message detailing the unit type and software version running

```
== Funktion One X04 ==  
==Software V 2,00 ==
```

and all LEDs will briefly illuminate. The unit will then begin its countdown to the wake-up procedure<sup>2</sup>, during which time the audio will fade up to the level last set. Metering will begin to operate when the fade-up starts.

## Preliminary Set-up

The procedure below should be followed when first installing a **4 Series unit**.

- ✓ Design your crossover! To do this, press **MENU**, and use the **BACK** or **NEXT** key to select 'Crossover sub-menu' and then press **ENTER**. Use the **BACK** or **NEXT** key to select 'Design a crossover' and then press **ENTER**. Finally, use the **BACK** or **NEXT** key to select the desired routing<sup>3</sup> and follow the set-up wizard to finalise your design.
- ✓ Note that when in a menu, **ENTER** is always used to confirm selections. The current selection is marked with an asterisk '\*'.
- ✓ Use the **EDIT** keys on each output channel with the **BACK** and **NEXT** keys to select the high pass filters, low pass filters, parametric EQs etc. Note that when designing a new crossover, the high and low pass filters will be set to default values.
- ✓ Use the **EDIT** keys on each input channel with the **BACK** and **NEXT** keys to select the gain, delay and parametric EQs available on each input.



Note that if no action is taken in menu mode, the unit will return to normal 'default' mode after about twenty (20) seconds. Repeat the above directions to return to menu mode.

<sup>2</sup> The wake-up time countdown may be adjusted in the SYSTEM menu – see page 252 for details.

<sup>3</sup> For details about adjusting the routing if one of the standard configurations does not suit, see page 14.



## Routing Options and Processing Blocks

Due to the completely new DSP platform, the routing possibilities within the **4 Series** have been made completely flexible, with a matrix available allowing any combination of inputs to be routed to any output. The additional DSP power has permitted the inclusion of more processing blocks, even considering the extra inputs and outputs, and the doubling of sample rate.

To reduce set-up time and aid usability, several standard configurations are available as described in a later section.

This section will outline the processing blocks available in relation to the signal path, and explain the various options for routing, including the "Free Assign" mode, which opens up completely flexible channel routing.

### Input Channel Makeup

The diagram below shows the processing available on each of the four input channels, before routing to the matrix.

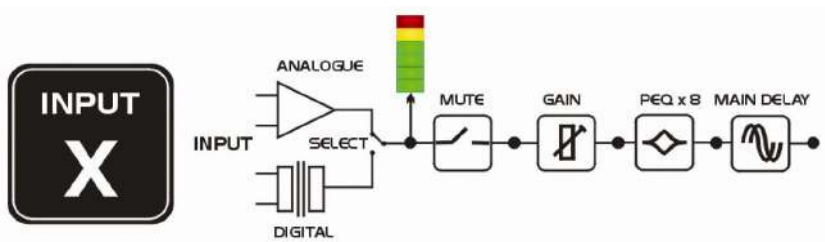

### Output Channel Makeup

The diagram below shows the processing available on each of the eight output channels, after routing from the matrix.

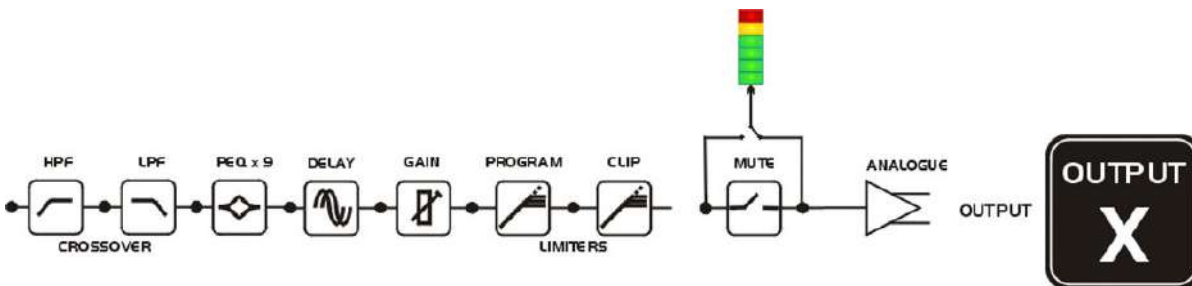

### Preset Routing Configurations (X04 shown)

In addition to the ability to assign any combination of inputs to any output, a number of preset configurations are provided, for use when designing a crossover from scratch. These have the advantage of suggested settings for the high and low pass filters to useful basic starting points, to filter the different outputs as appropriate for the chosen configuration. These may, of course, be freely modified afterwards should they not suit the requirements exactly.

The diagrams on the following pages show the connections made between inputs and outputs, and the suggested values chosen for the high and low pass filters.



**4 x 2 way crossover:** As shown, each input feeds a pair of outputs, odd numbers being the low frequency split, and even numbers being the high part of the spectrum. Default suggested crossover frequencies are shown by each output.

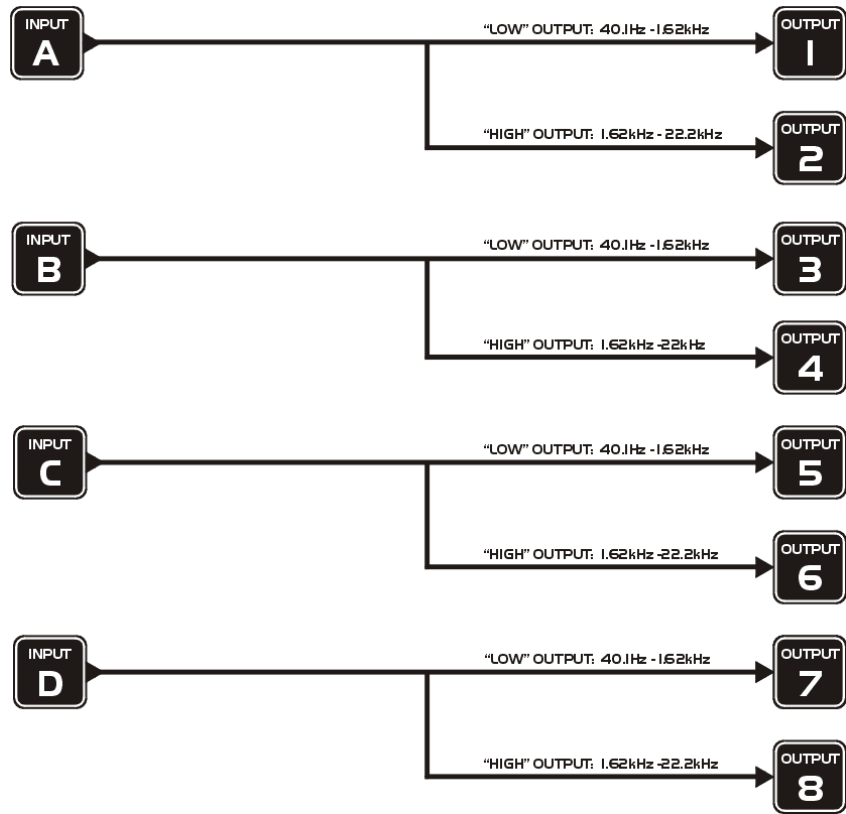

**2 x 3 way** and B feed three output 7 being fed from 'Aux' outputs are Default suggested frequencies are output.

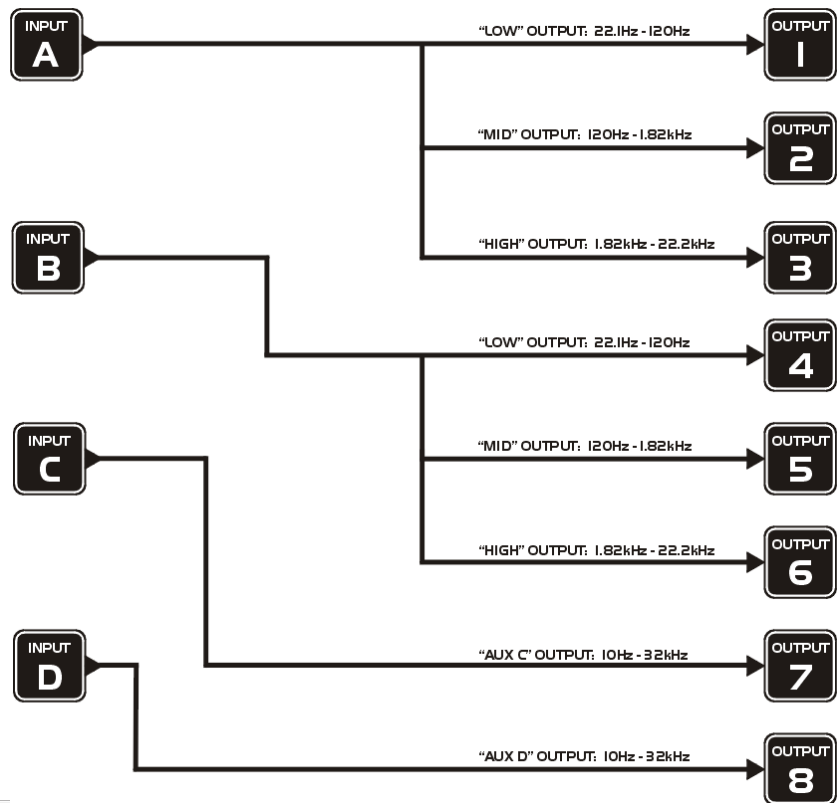

**crossover:** Inputs A outputs each, with from input C, and input D. Note the set to full range. crossover shown by each

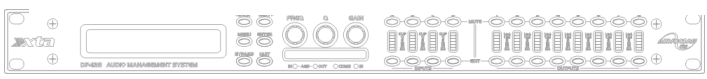

2 x 4 way crossover: Inputs A and B feed four outputs each, with inputs C & D being unused. Default suggested crossover frequencies are shown by each output.

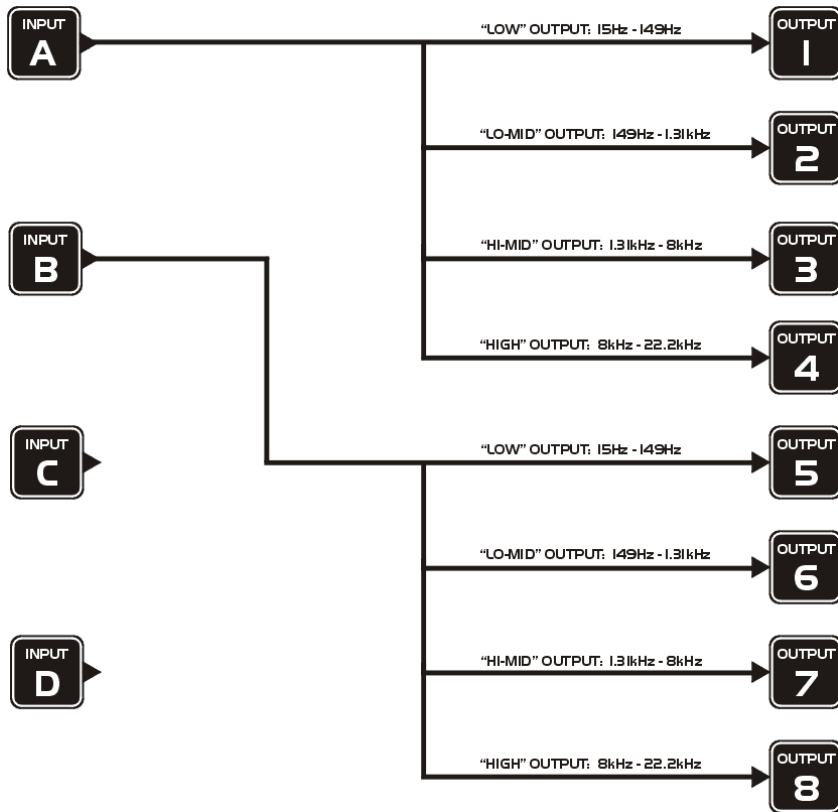

1 x 8 way crossover: Inputs A is fed to all eight outputs, with initial settings being all full bandwidth. The crossover points can be adjusted as desired.

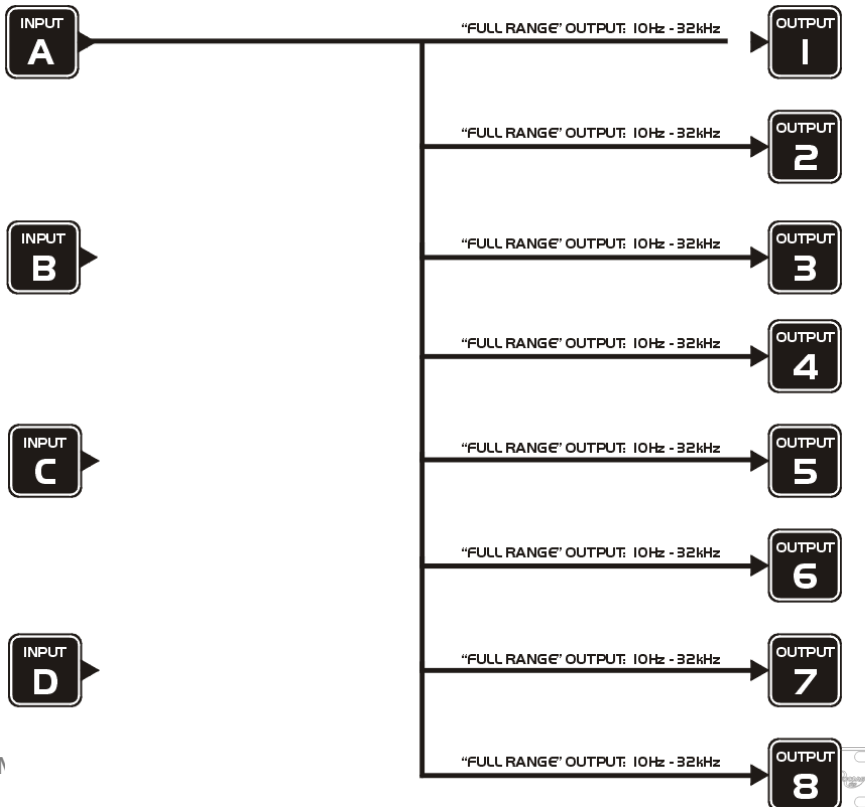

## Free Assign Routing

If none of the preset configurations are appropriate to the required system setup, it is possible to manually select the routing of the crossover. This is achieved through the **Crossover Menu** -> **Design A Crossover**.

Pressing **ENTER** will start the crossover design wizard, with the first option being to choose the routing.

The display will show

```
Design A Crossover ->
Routing = 2 X 4 WAY *
```

or whatever the current configuration is set to. Press **BACK** until the display shows

```
Design A Crossover ->
Routing = Free Assign
```

And then press **ENTER**. The **EDIT** key will illuminate for output 1, as will any relevant input **EDIT** keys, showing which inputs are feeding output 1. The display will also detail the current combination of inputs feeding this output. To change the routing for any output, press its **EDIT** key, and then choose the required input channel combination by just pressing the input **EDIT** keys as appropriate. The input combinations can also be stepped through in turn by pressing **NEXT**, or **BACK**.

To complete the procedure, press **ENTER**. The wizard will continue, and if the routing has been changed, all outputs will be muted on exit.



# Editing Audio Parameters – Input Channels

## Input Gain

The range of the control over the input gain is -40dB to +6dB in 0.1dB steps.

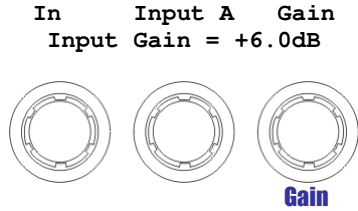

## Base Delay

The maximum available delay between any input and output is 650.00mS. For example, if the input delay on channel A is set to 500mS, the maximum available output delay for any output fed from input A will be 150mS. The readout units can be changed between time in milliseconds, distance in feet or distance in metres. Please see page 252 for more details.

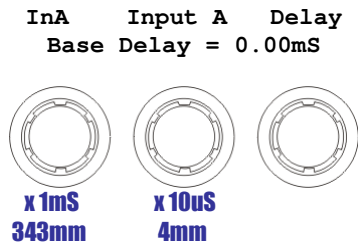

## Input Parametric EQ

There are eight bands of parameter equalisation available on every input. The behaviour of each individual band can be changed to a variety of different filter shapes, including high and low shelves and filters and notch. Changing the filter type is achieved by pressing **ENTER** during editing any particular band. For more details about the various types of filter available, please see page 41.

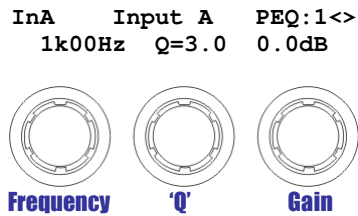

# Editing Audio Parameters – Output Channels

## Output Gain

The range of the control over the input gain is -40dB to +15dB in 0.1dB steps.

OP1      Output 1      Gain  
 Output Gain = +6.0dB

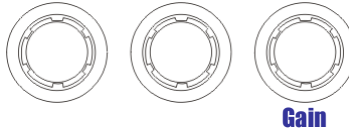

## Output Polarity

The polarity (or phase) of each output may be switched individually as below.

OP1      Output 1      Polar.  
 Polarity = [+]

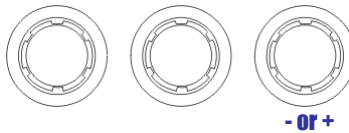

## Output Delay

The maximum available delay between any input and output is 650.00mS. For example, if the input delay on channel A is set to 500mS, the maximum available output delay for any output fed from input A will be 150mS. The readout units can be changed between time in milliseconds, distance in feet or distance in metres. Please see page 25 for more details.

OP1      Output 1      Delay  
 Delay = 0.0000mS

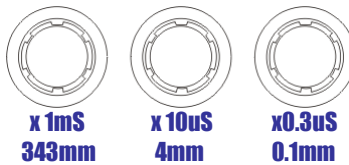

## Output High Pass Filter

The high pass crossover filter on each output has a frequency range of <10Hz up to 32kHz in 1/36<sup>th</sup> Octave steps. If you try to set the high pass filter to a higher frequency than the low pass (which would be pointless and result in no output), the message **High/Low Freq. Overlap!** will be displayed. Note that to access the 48dB/Octave filters, parametric bands 6 & 7 need to be bypassed, or set to 0dB. If they are not, the message **Bypass PEQ's 6 & 7 To Access 48dB Slopes** will be displayed.

```
OP1   Output 1   HPF /~~
<10Hz Linkw-Riley 48dB
```

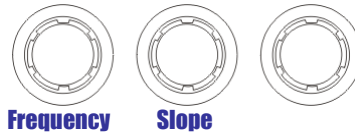

## Output Low Pass Filter

The low pass crossover filter on each output has a frequency range of 35.1Hz up to >32kHz in 1/36<sup>th</sup> Octave steps. If you try to set the low pass filter to a lower frequency than the high pass (which would be pointless and result in no output), the message **High/Low Freq. Overlap!** will be displayed. Note that to access the 48dB/Octave filters, parametric bands 8 & 9 need to be bypassed, or set to 0dB. If they are not, the message **Bypass PEQ's 8 & 9 To Access 48dB Slopes** will be displayed.

```
OP1   Output 1   LPF ~\
>32kHz Linkw-Riley 48dB
```

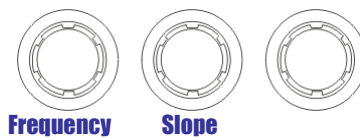

## Output Parametric EQ

There are nine bands of parametric equalisation available on every output<sup>4</sup>. The behaviour of each individual band can be changed to a variety of different filter shapes, including high and low shelves and filters and notch. Changing the filter type is achieved by pressing **BYPASS** to bypass the filter and then pressing **ENTER** during editing any particular band. For more details about the various types of filter available, please see page 41.

```
OP1   Output 1   PEQ:1<>
1k00Hz Q=3.0 0.0dB
```

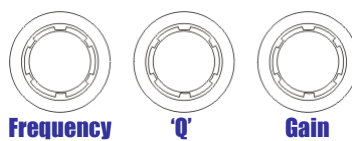

<sup>4</sup> Note that 2 bands each will be lost when using 48dB slope crossover filters, resulting in a maximum of 5 bands of EQ when both high and low pass are set to 48dB/Octave.



## Output Limiter

The limiter on each output has adjustable attack and threshold, with a release time that is selectable to be a multiplier of the attack time. For example, as shown below, the attack time is 2mS and release is "x16" so 32mS. The attack and release times can be automatically linked to the high pass filter frequency, so that they are set to correct values for the output's frequency range. If this feature is enabled, the display will show **Automatic T/C** in place of the attack and release times. Selection of automatic time constants is through the **Design a Crossover** wizard, in the **Crossover Sub-Menu**.

OP1 Output 1 Limiter  
Atk=2.0mS Rel=x16 +22dB



## Output "D-Max" (Clip) Limiter

The clip limiter on each output is designed to sit at a threshold just above the standard limiter and has a look-ahead attack so that its threshold can never be exceeded. The release time can be automatically linked to the high pass filter frequency, so that it is set to a value appropriate for the output's frequency range. If this feature is enabled, the display will show **Rel. = Auto** in place of the release time. Selection of automatic time constants is through the **Design a Crossover** wizard, in the **Crossover Sub-Menu**.

More information about the limiters and their use is given in the section on page 39.

OP1 Output 1 ClipLim  
Rel.=Medium 2dB Above

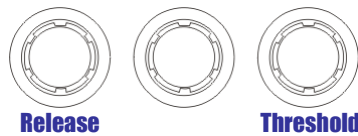

# Input Ganging and Output Ganging

The method of linking inputs or outputs together during editing is achieved in the same way, so only crossover (output) ganging will be explained here. Having selected **Crossover Ganging** from the menu under the **Crossover Sub-Menu**, the current ganging set-up will be displayed. This will either be a preset selection as would be useful in a standard crossover configuration – for example

<-Crossover Ganging  
Ganging=1+3+5+7 2+4+6+8

...would be a logical ganging arrangement if the crossover was set up as a 4 x 2 way – linking the control and adjustment of all “Low” outputs together, and that of all “High” outputs together.

However, if the crossover has not been set up with a preset routing configuration, then it may be required to set up the ganging to compliment this configuration. This is achieved using the **Free Assign** mode. This is selected from the preset ganging choices<sup>5</sup>, which are:

Ganging=None	[all outputs independent]
Ganging=Free Assign	[choose ganging]
Ganging=1+2+3+4+5+6+7+8	[1 x 8 way]
Ganging=1+5 2+6 3+7 4+8	[4 x 2 way]
Ganging=1+3+5+7 2+4+6+8	[2 x 4 way]

Selecting **Free Assign** and then pressing **ENTER** will begin the process of ganging outputs together using the following simple rules:

- ✓ All outputs are ganged to the lowest number – so to gang 3 & 5, 5 must be selected and then ganged to 3.
- ✓ Outputs cannot share more than one ganging set – so for example output 3 cannot be ganged to 2 and 4 unless they are ganged together as well. (Effectively 3 and 4 are ganged to 2 in this case)

With these rules in mind, selecting and setting up gangs is quite straightforward.



Press a **MUTE** key to choose the output to gang – its LED will begin to flash, and an **EDIT** key will illuminate to show which output it is currently ganged with. To change this selection, just press another **EDIT** key, remembering that gangs work from the highest to lowest number. So, to gang outputs 1 and 5, press **MUTE 5** then **EDIT 1** – the display will show

<-Crossover Ganging  
Gang Output 5 with 1

Ganging is cleared by selecting **Ganging=None** from the initial choices given above. The **Input Ganging** procedure is identical to the crossover ganging, selectable under the **Input Sub-Menu**.

<sup>5</sup> Ganging choices will be dependent on the **4 Series** unit in question and how many outputs it has.



Note: 'Polarity' is the only attribute that is not ganged when ganging is assigned. This is to compensate for any fault in the signal chain.



# Menu System Overview

Below is an overview of the menu system – a lot of functions have been assigned menu shortcuts – these are accessible directly from the default screen by pressing **MENU** followed by the appropriate **MUTE** or **EDIT** button as shown. This table only shows the top level of each menu item – some of these will start wizards or access additional functions, and these will be explained in later sections.



To jump back to the last menu item accessed directly from the default screen, press **MENU** three (3) times – first press is into menus, second is a jump to the sub-menu, third is to the item...

MAIN MENU						
GLOBAL MEMORY	INPUT SECTION	CROSSOVER	INTERFACE	SYSTEM	SECURITY	AES/EBU
Recall a Memory 	Input Ganging 	Design Crossover 	External Interface 	System Status 	Unit Locking 	AES Status Info. 
Store a Memory 	Input Reset 	Crossover Ganging 	Wiser Setup 2400	LCD Contrast		
Erase a Memory			GPI Interface	LED Brightness		
				Temperature Alarm		
				Wake-up Time		
				Output Meters		
				Filter Q/Bandwidth 		
				Delay Time/Dist'nce 		
				Clip LED Hold Time		
				Set Date & Time		



Note that if no action is taken in menu mode, the unit will return to normal 'default' mode after about twenty (20) seconds. Repeat the above directions to return to menu mode.













# Menu System Shortcuts

A lot of functions have been assigned menu shortcuts – these are accessible directly from the default screen by pressing **MENU** followed by the appropriate **MUTE** or **EDIT** button as shown. The entire list of features accessible in this way is given below. *Note that currently the menu shortcuts only apply to the XO4.*

- MENU **A** -----
- MENU **B** Store Input Memory
- MENU **C** Store Crossover Memory
- MENU **D** Store Global Memory
  
- MENU **A** -----
- MENU **B** Recall Input Memory
- MENU **C** Recall Crossover Memory
- MENU **D** Recall Global Memory
  
- MENU **1** System Status
- MENU **2** External Interface Set-up
- MENU **3** -----
- MENU **4** Filter Q/Bandwidth Display Readout
- MENU **5** Delay Units Time/Distance Readout
- MENU **6** AES Input Status
- MENU **7** -----
- MENU **8** -----
  
- MENU **1** Design a Crossover
- MENU **2** Input Ganging
- MENU **3** Crossover (Output) Ganging
- MENU **4** Input Reset
- MENU **5** Unit Locking
- MENU **6** -----
- MENU **7** -----
- MENU **8** -----



# Menus in Detail

GLOBAL MEM.	
Recall a Memory 	Recall Input or Crossover Memories or combinations of.
Store a Memory 	Store Input or Crossover Memories or combinations of.
Erase a Memory	Erase Input or Crossover Memories or combinations of.
INPUT SECTION	
Input Ganging 	Gang (link) inputs together so their parameters track.
Input Reset	Start wizard to reset sections of input parameters.
CROSSOVER	
Design Crossover a 	Set up a new crossover from scratch. This selection starts a wizard to guide through the process. Also select this to alter the set-up of the current crossover.
Crossover Ganging 	Gang (link) outputs together so their parameters track. Note: 'Polarity' is the only attribute that is not ganged when ganging is assigned. This is to compensate for any fault in the signal chain.
INTERFACE	
External Interface 	Starts a wizard to configure the baud rate, ID and port selection of the remote interface.
Wiser 2400 Setup	Configures wireless interface (if connected).
GPI Interface	Configure the GPI inputs used for closed contact memory recall (hardware option).
SYSTEM	
System Status 	Displays a series of information screens including software version, temperature, hardware and firmware versions, date and time. Press <b>NEXT</b> to jump through info.
LCD Contrast	Adjust the viewing angle of the screen.
LED Brightness	Adjust the brightness of all the meters and button LEDs.
Temperature Alarm	Set the threshold for the unit to flash a warning temperature message on the screen.
Wake-up Time	Adjust the time before the audio fades in on start-up – can also be set to keep mutes on when powered up.
Output Meters Opt'n	Select the monitoring point for the meters – either pre or post mute (so meters can be set to work even when outputs muted)
Filter Q/Bandwidth 	Select the readout units for the 'Q' setting of parametric filters – 'Q' is 1/Bandwidth (in octaves) – small 'Q' values mean wide response variations.
Delay Time/Dist'nce 	Select the readout units for all delay values – either time, or distance in feet or metres.
Clip LED Hold Time	Select the time that the input CLIP LEDs stay illuminated for after an overload has passed.
Set Date & Time	Adjust the real time clock settings.
SECURITY	
Unit Locking 	Protect the unit against unauthorised access with a password - please see page 32 for more details.
AES/EBU	
AES Status Info. 	Information screen showing details of the incoming AES streams (sample rate/lock).



# Memory Structure

As with the **X01**, the **4 Series** have their memories split into sections, allowing independent recall of crossover settings (i.e. all parameters associated with outputs), and input settings.

There are, therefore, two types of memory available – **INPUT** and **CROSSOVER**.

These, and a combination of the two, appear in the **GLOBAL MEMORY Sub Menu**, and its operation warrants a little more explanation.

Selecting to **Store** or **Recall** using the **Global Memory** option offers the possibility of storing a combination of the available memory types, and these are selected using the **BACK** and **NEXT** keys.

To explain how this all works, please consider the following example.

6 memories stored in the unit with various combinations of input and crossover memories:

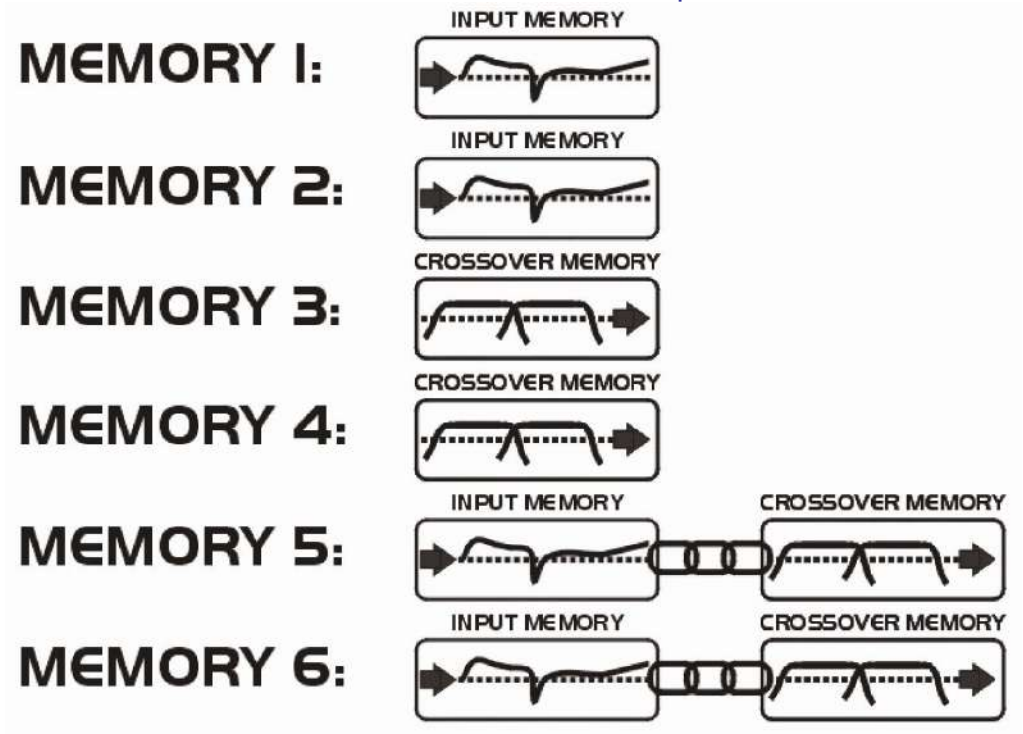

As can be seen, different memory locations contain different memory types and combinations thereof. If it is required to recall a location that contains Input and Crossover settings, this will limit the selection as shown overleaf...



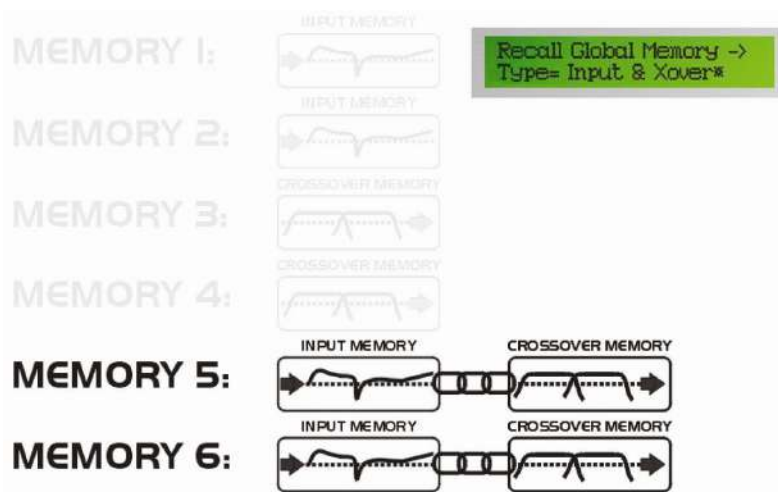

As only memory 5 and memory 6 have both types stored, these will be the only numbers available when recalling Input AND Crossover Memories.

However consider the example where the type of recall is set to Crossover Only.

There will be four memories to choose from in this case, as location 3&4 have only Crossover settings stored whilst memories 5&6 have Input and Crossover settings.

However recalling 5 or 6 as a Crossover memory will leave the current Input settings untouched.

It is possible to recall part of a memory, as long as it contains the memory type required.

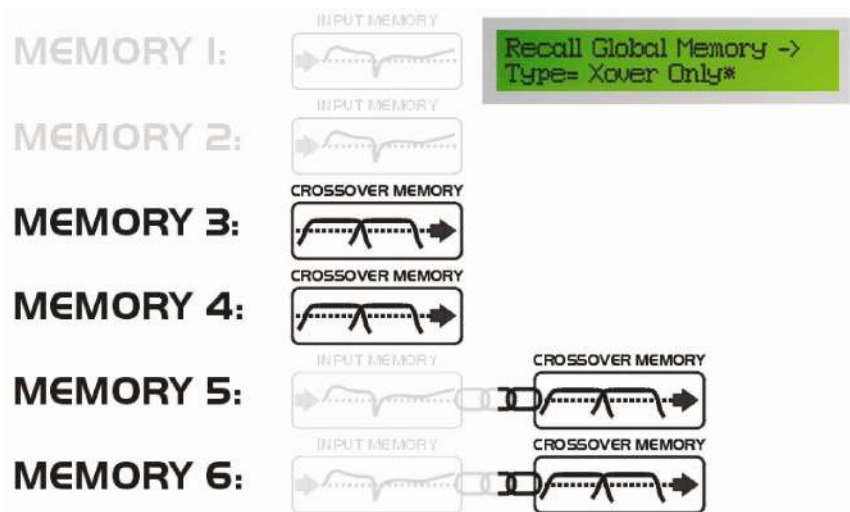

Note that storage and erasure of memories does not follow quite the same rules, being simpler in its operation.

Selecting Input and Crossover during a Store will skip any memories that have other combinations in them.

Selecting Erase for any combination will show only locations that have EXACTLY that combination – it is not possible to erase just one part of a combination memory.

The **4 Series** have 256 memory locations, but these are dynamic in nature – obviously a memory containing Input, Graphic and Crossover settings takes up more space than one containing just Input settings. Storage of 56 memories containing Input and Crossover settings is possible.

After Memory 256 the units are supplied with the latest Funktion One system settings. A list of which can be found with the settings download at [www.funktion-one.com](http://www.funktion-one.com).



# Preset Files and Loader Program

All Funktion One OEM 4 Series Loudspeaker Management Systems are dispatched with the most recent setting presets available. If you find that a unit has lost its settings you will need to load these via the Funktion One loader program, which can be found here: <http://www.funktion-one.com/settings/downloads>.

Presets are loaded through the 9-pin serial connector (RS232) on the back of the crossover. The most basic way to connect is with an RS232 cable (9 pin to 9 pin). If your computer doesn't have a 9-pin serial port, a USB – RS232 converter like the Aten UC232a can be used ([http://www.audiocore.co.uk/tech-support-docs/Remote Interfaces.pdf](http://www.audiocore.co.uk/tech-support-docs/Remote%20Interfaces.pdf)). The Aten unit is on page 4. Read the instructions with your USB – 232 adapter carefully before connecting it for the first time, Windows will need to install the drivers which should come with the adapter on a disc.

When you connect the XO\* unit to your computer and switch it on you will get the familiar "bing-bong" sound. Once you've connected you need to open the application FunktionOneFlashLoaderV1.50, if all is well then it should show that it is connected. If status is "No Connection" then you probably have the wrong Serial Port setting. Com 1 will be for a 9 pin connection on the computer. In Windows, right click "My Computer" and click properties and then Device Manager. Double click Ports and you should see something like ATEN USB to Serial Bridge and a Com port number in brackets. In the image it says (Com 3):

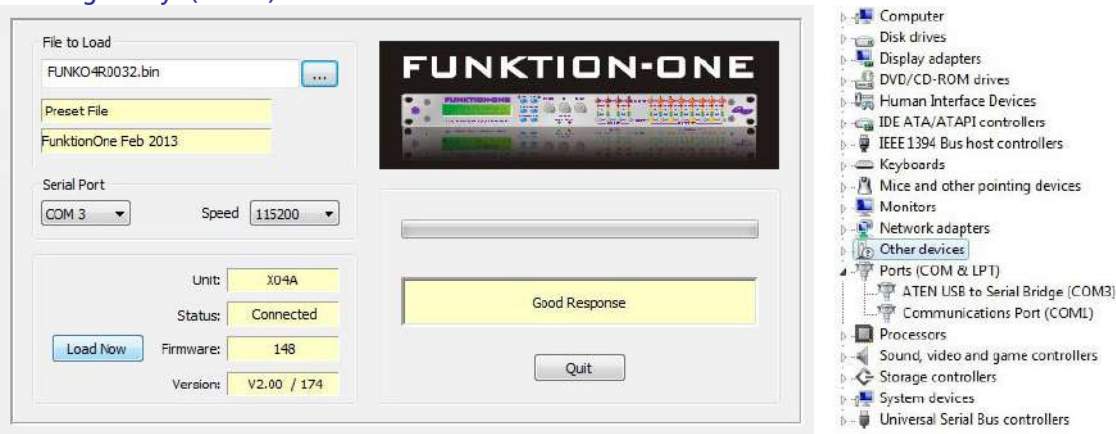

Set the Serial port in Funktion One Flash Loader to this number, and click connect. You should now be connected to the XO unit. Now at the top of the application window, click on the button next to "File To Load", navigate to your preset BIN file and double click on it or click Open. Now click the "Load Now" button. A popup will open to ask "Confirm Load Presets?" Click "OK"

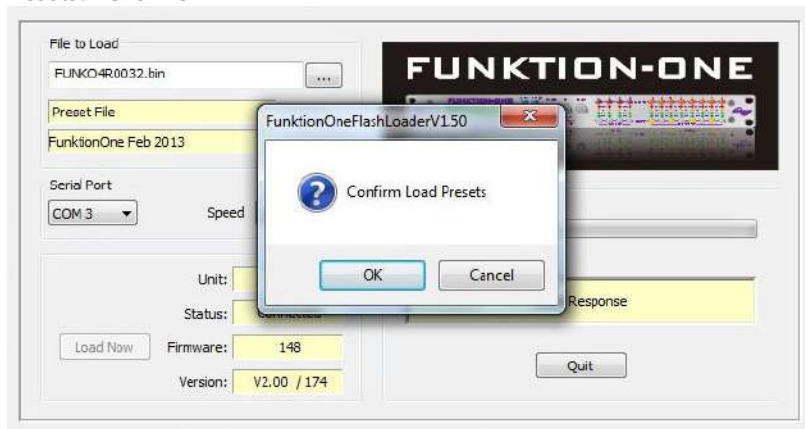

The application will show loading progress and close automatically.



# Remote Control Interface Operation

## RS232 Interface

This interface is fitted as standard to all units and is accessed via the 9-pin D-type connector on the rear of the unit. Note that to connect to a computer's COM (serial) port correctly, a one-to-one cable must be used, NOT a 'null modem' cable. A 'null modem' cable has the 'transmit' and 'receive' wires swapped over and will not work.

The RS232 connection is suitable for distances of about a maximum of 25 feet (7.6m) between the PC and the unit. If you experience problems with the connections, consider

- selecting a slower baud rate
- selecting the 'Use Acknowledge Cmd' option in AudioCore (see the Remote Menu > RS232 Configuration window)
- running the unit via the RS485 interface

Note that only one unit at a time may be connected to the computer via this interface. Additional units may be 'daisy-chained' via the RS485 connections from the back of the first one (it acting as a converter for them), but their RS232 ports are not used.

## RS232 Connection (Single Unit)

A typical interface set-up might involve running an RS232 link from laptop or a desktop computer to an **XO4** unit set up as a master unit. The diagram below shows this method of connection, the required menu options are also given. Note that the RS232 cable must be a 1-1 connection type, NOT a null modem cable (which has connections crossed internally).

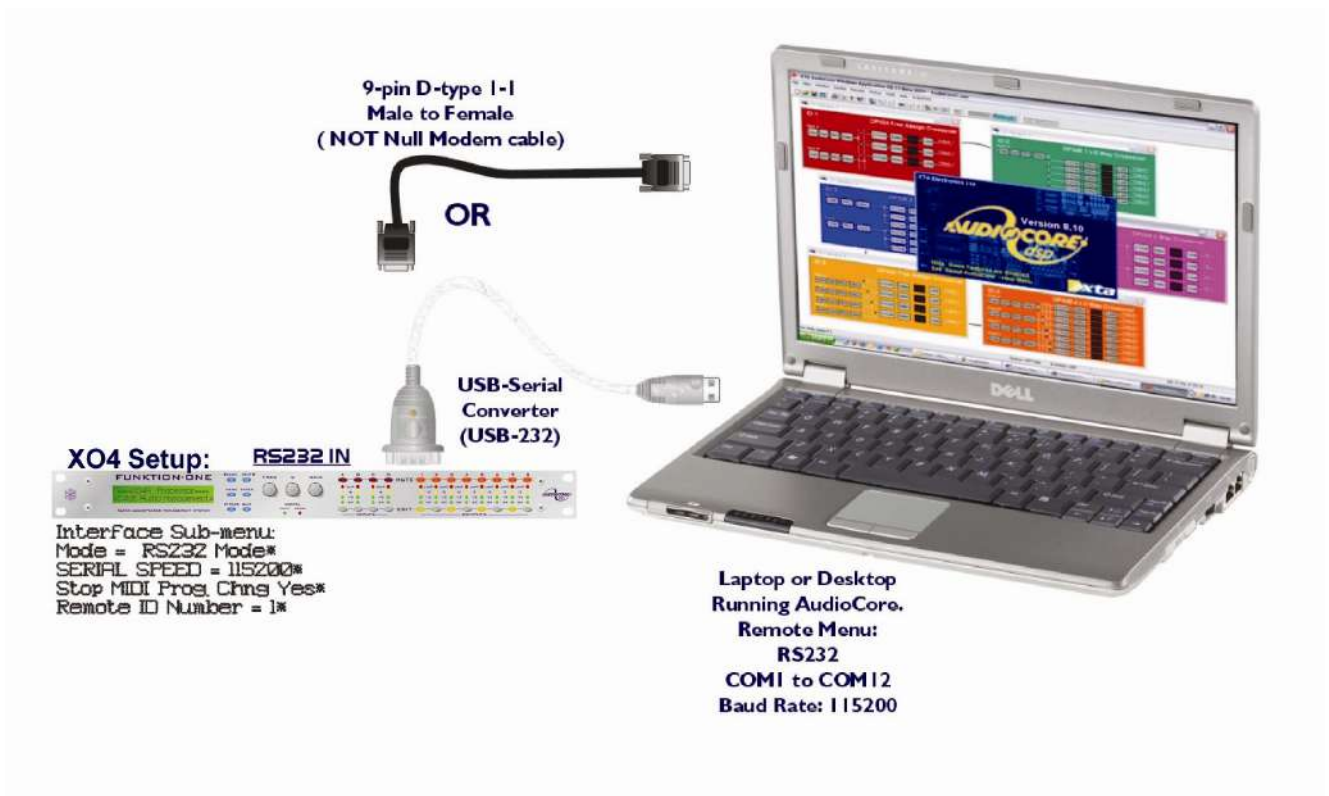

## Loading New Software via a PC

The unit's internal software may be updated via the RS232 port **ONLY**, one unit at a time. We recommend disconnecting all other devices when updating the software.

The unit's interface must be set as RS232 Master on ID1 for the PC loader program to recognise it and allow the update to be sent.

Download the latest version of the loader program and the unit software from [www.funktion-one.com](http://www.funktion-one.com), and follow the instructions included with this zip file. An RSS feed is available from [www.xta.co.uk](http://www.xta.co.uk) to ensure immediate notification of software releases.

### RS232 Connection (Multiple Units)

If control over multiple units is required, typically the slaves will be set up to run from the RS485 ports on the master unit. Note the incremental 'ID NUMBER' option in the unit's interface setup.



9-pin D-type I-I  
Male to Female  
(NOT Null Modem cable)

OR

USB-Serial  
Converter  
(USB-232)



Laptop or Desktop  
Running AudioCore.  
Remote Menu:  
RS232  
COM1 to COM12  
Baud Rate: 115200

**XO4 Setup:** **RS232 IN**

Interface Sub-menu:  
Mode = RS232 Mode\*  
SERIAL SPEED = 115200\*  
Stop MIDI Prog. Chng Yes\*  
Remote ID Number = 1\* **XLR - XLR**

**XO4 Setup:** **RS485 IN**

Interface Sub-menu:  
Mode = RS485 Mode\*  
SERIAL SPEED = 115200\*  
Stop MIDI Prog. Chng Yes\*  
Remote ID Number = 2\* **XLR - XLR**

**XO4 Setup:** **RS485 IN**

Interface Sub-menu:  
Mode = RS485 Mode\*  
SERIAL SPEED = 115200\*  
Stop MIDI Prog. Chng Yes\*  
Remote ID Number = 3\*

Additional units  
may be set up as slaves  
with incremental ID's



## Shadow ID Numbers

Shadow ID numbers allow extra units to share the same ID and follow the settings of the 'main' ID. This is useful for larger systems (for example anything above a 4-way stereo system) where it is only necessary to set up one side of the system, and allow the other unit to track it identically.

Using the shadow IDs in this way also reduces the apparent system complexity within AudioCore. This is due to the fact that shadow ID's NEVER send back any settings to AudioCore and because of this will NOT appear in the list of connected units.

They can be thought of as listening to and acting upon all information addressed to them, but not replying. Up to 128 shadow units may be connected and assigned the same ID as the 'main' unit, but remember that the maximum total units on any one RS485 network is 128.

Shadow ID numbers are accessible when the unit's interface is configured, and will appear after ID number 128, starting from 1 again, but designated shadow IDs with an 's' after the number – 1s. Any ID can have multiple corresponding shadows.

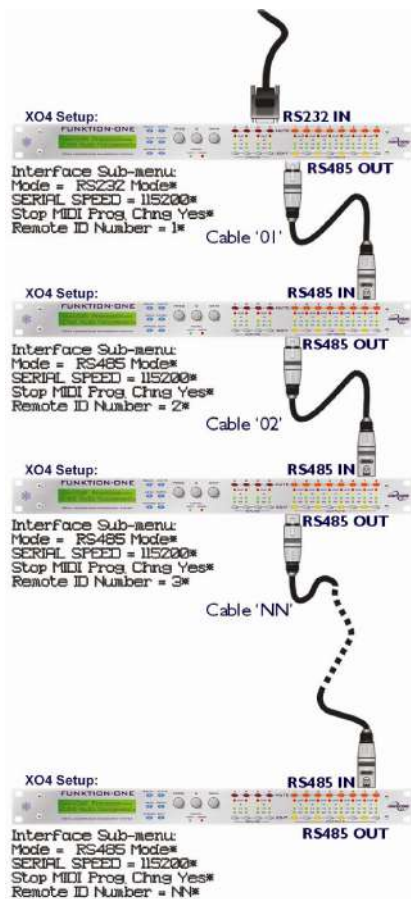

## RS485 Interface

This interface is fitted as standard to all units and is accessed via the 3-pin XLR sockets on the rear of the unit. Cables to connect units together or to an RS232-485 converter will need to be wired one-to-one. We recommend the use of standard shielded microphone cables, or a balanced feed from a multicore.

RS485 is a fully balanced system, capable of sending data over distances of up to one kilometre. Note, however, that this is the *total* length of connection. The RS485 output of each unit is purely hardwired from the input and so no electrical regeneration of the signal is provided. What this means is that the distance from the *first* RS485 output to the *last* RS485 input must not exceed 1km in total.

As this diagram illustrates –  
The combined length of cables 01 + 02 + ...NN < 1000 metres.

Note that this includes any units set up as shadow IDs.

Units may be connected in a star configuration if required, so a long cable may be used and then a hub formed with units all connected to this, but we do not recommend daisy chaining these configurations together.

XTA has a range of tried and tested interfaces, all of which are listed in the XTA Interface Guide, available from their website. They can supply all the interfaces described in this guide directly.





If your laptop or PC does not have a spare serial port (or any serial ports for that matter!), the RS485 converter must be connected through a USB – Serial converter. The RS485 converter that XTA recommend is available in two types – the standard K2, and the more advanced K2-ADE version. Only K2-ADE version will work with USB-Serial converters, as these converters do not support the extra handshake lines used with the standard converter.

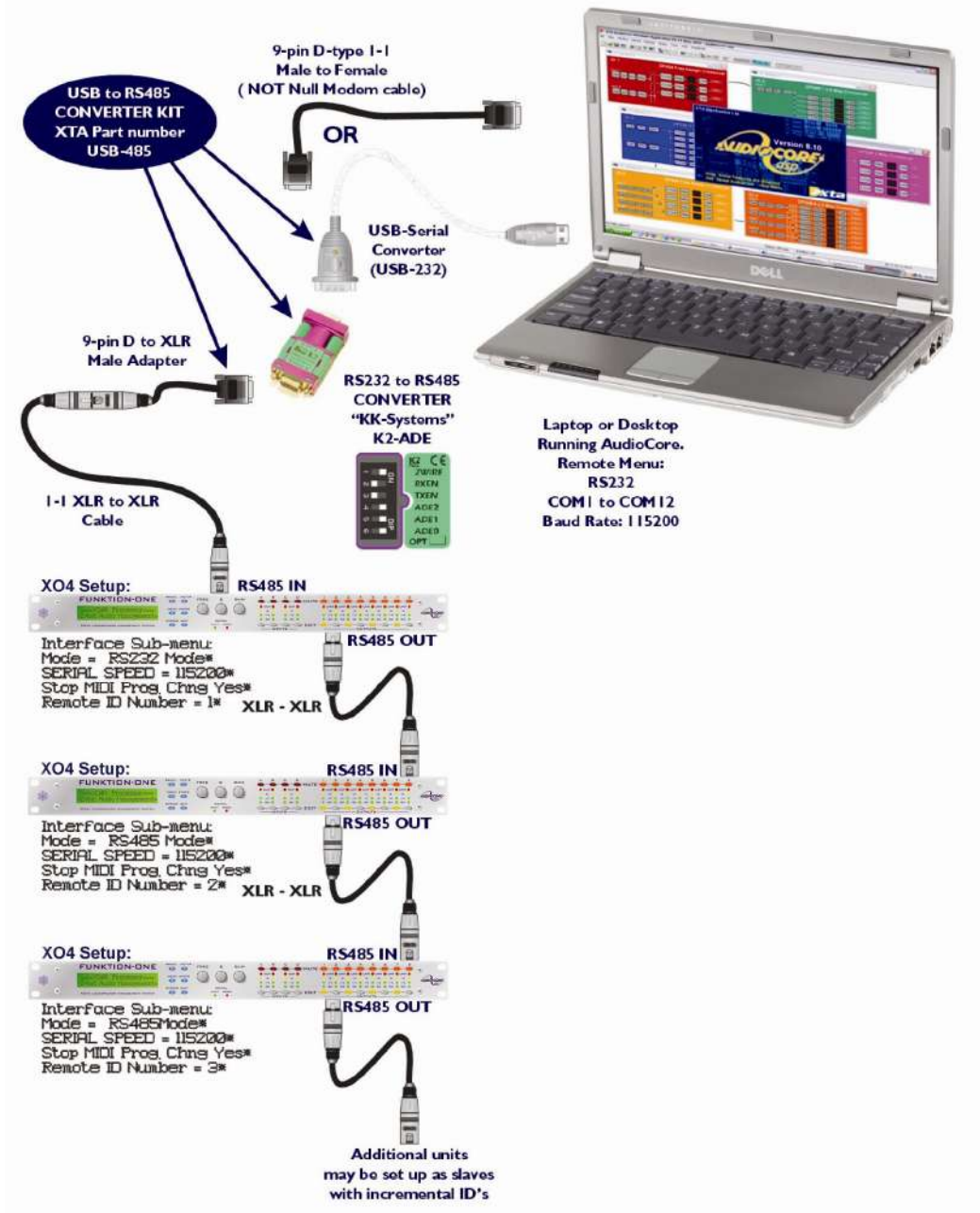

Both the converters and the required adapter cables are available from XTA. The adapter is available in a kit, which includes a USB-Serial converter, the XLR to 9-pin adapter, and the K2-ADE converter itself. This complete kit is part number USB-485. XTA has a range of tried and tested interfaces, including USB and wireless solutions, all of which are listed in the XTA Interface Guide, available from their website. XTA can supply all the interfaces described in this guide directly.



# AES Inputs

The **4 Series** units have a full AES implementation built in as standard. This allows the unit to receive digital audio directly. The switching of digital input can be performed independently, and the inclusion of sample rate converters on the inputs allows the unit to accept sample rates from 32kHz up to 192kHz.

## AES Input

Input selection is via a recessed switch on the rear panel of the unit, between input D and output 1. A red LED inside this aperture illuminates to show that the AES digital inputs have been selected.

A complimentary LED on the front panel also illuminates. The switch controls the rear panel LED directly, whilst the front panel one is via the processor, allowing it to relay a little more information.

If it is flashing, this means that AES inputs have been selected but have not locked. Once a stable AES signal is being received, it will be permanently illuminated.

The AES inputs are marked on the rear panel – for channels A & B use input A, and for channels C & D use input C.

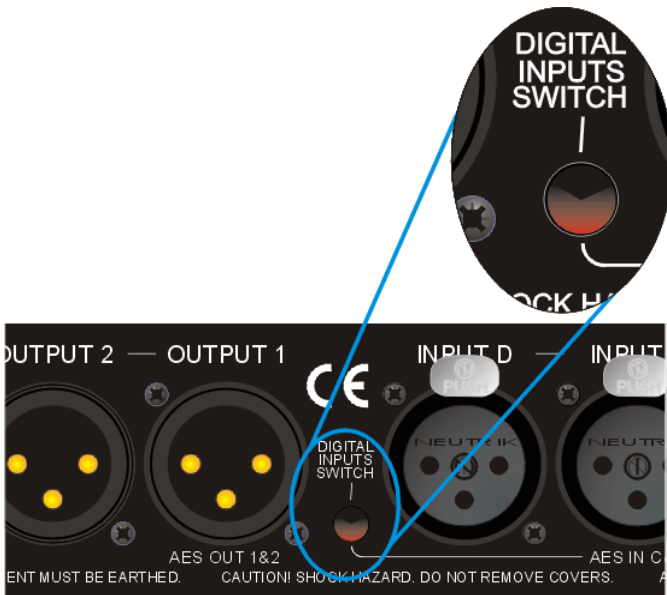

## AES Diagnostics and Status Information

Also under the AES/EBU Sub Menu is the AES Status Information option, which can be used to check the incoming sample rate(s) and confirm that the data is being received correctly.

Pressing **ENTER** will first show

```
AES Device Status
V1: E  V2: E  V3: -
```

This display shows the correct operation of the two AES transmitters V1 and V2; V3 is redundant. The letter after each is the silicon version (and is of no importance to the user).

Pressing **ENTER** again will show

```
AES Device Status
V : 96k0  V : 96k0
```

This display shows the status of the two AES receivers, input A on the left, and Input C on the right. The sample rate the unit has been able to lock to is shown, or **UNLOCKED** will be displayed in its place. The unit will lock to sample rates from 32kHz up to and including 192kHz.

The unit's own processing sample rate is 96kHz. Internal sample rate converters will translate all incoming rates to 96kHz – one converter for each AES input. This allows the two input streams to be at different rates if necessary.



# Security and Locking

After selecting the **Security Sub Menu** and pressing **ENTER**, select one of the lock types, choosing the most appropriate one for your application. As ever, **ENTER** will confirm your selection.

### User Specific

Upon pressing **ENTER** to select this type of lock, each parameter group is presented in turn. Choose the type of lock (as above) using the **FREQ** encoder, and press **ENTER** to confirm each parameter. After the last parameter, the unit requests a password. The description of this operation is given at the end of this section.

This option allows the user to specify, for each type of parameter, whether it is to be completely accessible ('No Lock'), viewable but not adjustable ('Control'), or effectively unavailable ('Display'). The ability to operate mutes, store or recall memories, or even access the menus may also be locked.

### Xover Only

All input parameters are available, but only the gain trim ( $\pm 6$ dB) is available on the outputs, effectively locking all the crossover settings. All mutes remain active.

### Xover + Trim

All input parameters available, but no output parameters – the crossover sections are completely locked. All mutes remain active.

### Xover + Trim + Mute

As for 'Xover + Trim' but additionally, output mutes are locked. Input mutes remain active.

### Changes Only

All parameters may be viewed, but none may be adjusted. This applies to both inputs and outputs. All mutes remain active.

### Changes + Views

No parameters are accessible – in effect the **EDIT** keys do nothing. All mutes remain active.

### Changes + Mutes

All parameters may be viewed, but none may be adjusted. This applies to both inputs and outputs. All mutes are also locked.

### EVERYTHING

No parameters are accessible – in effect the **EDIT** and **MUTE** keys do nothing.

## Entering the Password to Complete the Locking Operation

After selection of the lock type from the list above, a four-digit security code will be asked for. This can be entered by using the **FREQ** control to select a character, and the **BACK** and **NEXT** keys to move to the next character.

Alternatively, the **EDIT** keys can be used to enter a code by pressing any combination of the eight buttons. Each **EDIT** key represents its channel labelling, so any combination of **A, B, C, D, 1, 2, 3, 4, 5, 6, 7** and **8** can be used as a code, as shown below. Press **ENTER** to accept code and then re-enter it to confirm.

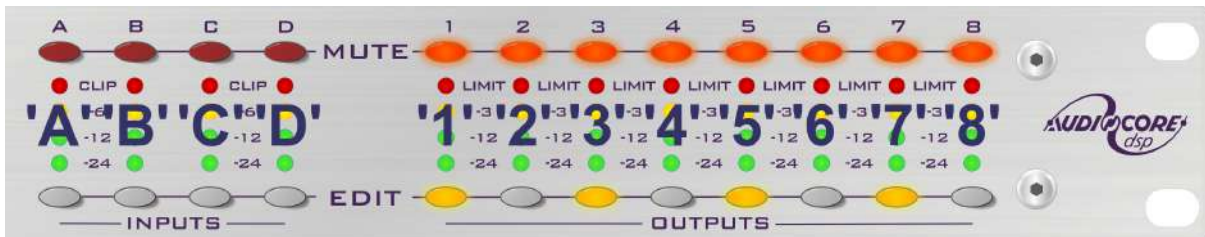

To prevent external computer control being used to adjust locked settings, be sure to set the external interface to OFF before locking out the unit.



## Unlocking the Unit

To unlock the unit press **ENTER** and then type the code in. This can be entered by using the **FREQ** control to select a character, and the **BACK** and **NEXT** keys to move to the next character. Alternatively, the **EDIT** keys can be used to enter a code by pressing any combination of the eight buttons. Each **EDIT** key represents its channel labelling, as described in the locking section.

## Forgotten the Password?

Don't panic! Your unit can still be unlocked. In an attempt to improve the security system on the **4 Series**, and prevent a standard master password from becoming common knowledge, the units now have a random password key generator.

The procedure for unlocking a unit using the password override is explained below:

Switch the unit on with the **MENU** key held in momentarily. After a few seconds, the unit will ask for a security code. Use the **EDIT** keys in the same manner as for entering lock codes (see page 32 for details) and enter 2121.

The display will show:

**Enter XTA Supplied Code:**  
**Break Code = 12345 [NNNN]**

The Break Code (in this example 12345) should be noted and supplied to XTA (+44(0)1299 879977). They have software to generate the corresponding Pass Code which should be typed in, followed by **ENTER**. This will unlock the unit and wipe the previous password.

Note the following about this procedure:

Once the Break Code has been noted, do NOT press **MENU** again during the operation of the unit (except to get back to this point on power up), or a different code will be generated. The unit may be used as normal, but every press of **MENU** will change the Break Code, so the Pass Code XTA supply will not work!

The unit may be switched on and off as necessary – just be sure NOT to press **MENU**, or the entire Break Code procedure will have to be repeated.





## "D-Max" Clip Limiter

The main limitation with traditional dynamics control is the inability of the processing to react truly instantaneously to the signal. One of the most significant advantages of digital signal processing over analogue is the ability to delay the audio signal precisely and without extensive complex hardware. The entire domain of digital signal processing is based around the combination of delaying, multiplying, and accumulating numbers (representing samples of audio) to implement all the filters and dynamics processing we have come to expect today.

In the case of dynamics processing, being able to delay a signal allows the processor module to delay the main signal in relation to the sidechain (the signal being monitored relative to the threshold), so that it can compensate for peaks prior to the arrival of the main signal.

Consider the situation of a monitor engineer listening to a band perform. Having no access to dynamics processors, he has had to resort to manually 'riding the faders' in an attempt to keep control of the levels. Should the level of one of the channels on his desk reach an unacceptably high level, he will turn it down appropriately.

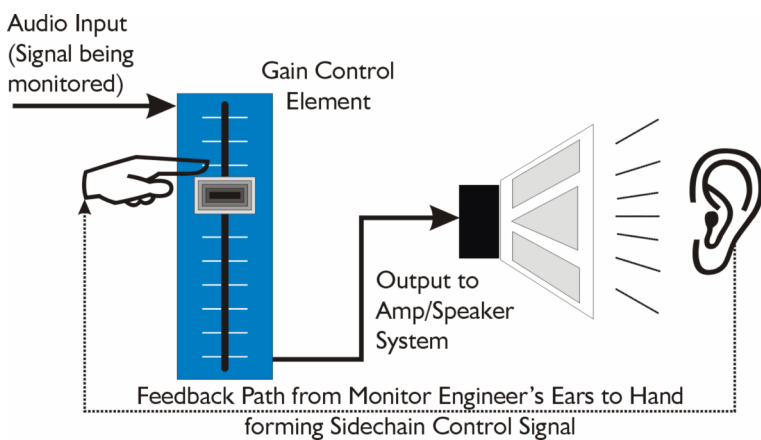

There is a hidden side-chain in operation even in this case. The main signal path is fed through the monitor desk and the gain controlled by adjusting the fader. The side-chain is formed by the feedback path between the engineer's ears checking the level and his brain instructing his hand to turn the fader down if the volume goes over the threshold he has chosen.

In this case, the delay between the signal actually going over the threshold, the engineer registering the situation, and then turning the signal down will be in the order of several hundred milliseconds at best. This will only be true if he is not distracted – in reality, it may be several seconds before any gain reduction is imposed on the signal to bring it under control.

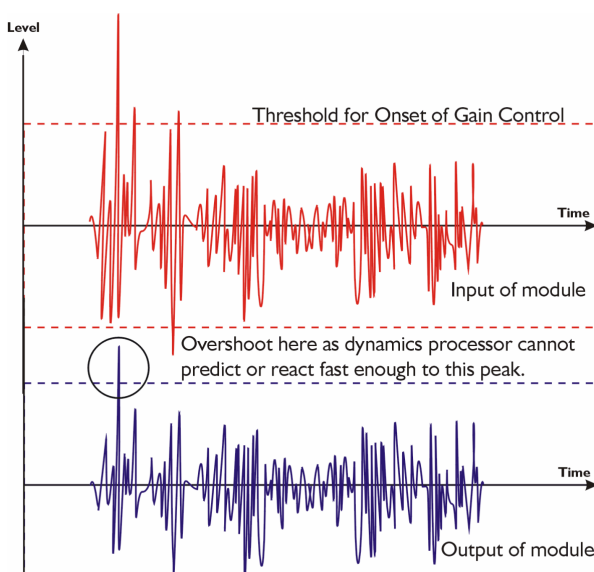

For an analogue dynamics processor, the situation is much better. Controlling the gain electronically, and not relying on a human sidechain feedback mechanism, it can react much more quickly.

The red waveform represents the input to the dynamics module, with the dotted line showing the threshold for gain control to occur. There are several peaks towards the start of this signal that are above the threshold, and so the dynamics processing should react to these as appropriate. (In this case reduce the gain).

The blue waveform shows the output of the dynamics module. The circled peak demonstrates that the processor has missed the first peak above the threshold (as it is very fast and short), but has 'caught up' shortly afterwards, keeping all other peaks under control. As it is unable to predict what is coming, this will always be a failing with analogue dynamics processing.

The **4 Series** ‘D-Max’ limiter predelayes the side-chain signal, resulting in a “zero overshoot” limiter, which is able to catch all peaks and provide a reliable absolute maximum setting for the output of any channel.

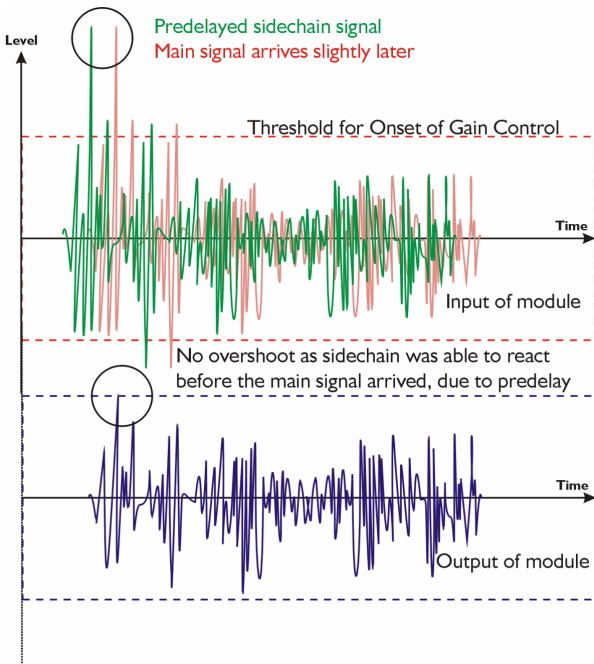

The predelayed side-chain is shown in green, with the main signal in red. As the main signal arrives slightly after the side-chain, the output from the unit does not suffer from the overshoot problem.

Remember that this delay is only in the order of tens of uS, and is a predelay – the side-chain is moved back in time in relation to the main signal. Inserting a delay into the main signal path of an analogue dynamics processor will achieve similar results, but with the penalty of delaying the main signal by the amount of look ahead delay introduced.

The “D-Max” limiter which appears in output lists just following the traditional limiter, has only two parameters to adjust:

```
OP1   Output 1   ClipLim
Rel.= Medium 10dB Above
```

The release time (either **Fast**, **Medium**, or **Slow**) and the threshold. Note that the threshold is set to be a minimum of 2dB above the threshold of the program limiter – setting the threshold to **10dB Above**, as in the example, means that no more than 10dB of overshoot above the threshold of the program limiter will ever be allowed.

The release time may also be set to follow the High Pass filter of the output – this is achieved through the **Design a Crossover** sub-menu, and will result in the display changing to show

```
OP1   Output 1   ClipLim
Rel.= Auto 10dB Above
```



## Setting Accurate Limiter Thresholds

The limiters built into the **4 Series** are intended to be used for loudspeaker driver protection, as opposed to amplifier protection. All modern professional power amplifiers designed for live sound use have their own limiters, which are tailored to protecting the amplifier from clipping.

The following section describes how to set up the units' limiters to provide exceptional protection against driver overheating, and cone over-exursion.

Most speaker systems are given a power rating in Watts RMS. This is the maximum continuous power that the system will handle and often appears very conservative. In reality, as music program is far from continuous in nature, the peak power of the system is much higher – up to ten times the continuous figure. Any limiter, which is to protect the driver from damage, must be able to fulfil the following tasks:

- Have an attack time which is calculated to allow transients through but keep the RMS level below the speaker manufacturer's specification;
- Have a release time which is sufficiently long to avoid the limiter itself modulating the program;
- Be intelligent enough to adjust the envelope of the limiter according to the frequency content of the program material.

The program limiters are capable of performing all these tasks. The only parameter that the user must set manually is the threshold, and it is crucial that this is done correctly. Consider the table below.

dB	Ratio	Vrms	Pwr 8 Ω	Pwr 4 Ω	Pwr 2 Ω
45	177.83	137.74	2371.71	4743.42	9486.83
44	158.49	122.77	1883.91	3767.83	7535.66
43	141.25	109.41	1496.45	2992.89	5985.79
42	125.89	97.52	1188.67	2377.34	4754.68
41	112.20	86.91	944.19	1888.39	3776.78
40	100.00	77.46	750.00	1500.00	3000.00
39	89.13	69.04	595.75	1191.49	2382.98
38	79.43	61.53	473.22	946.44	1892.87
37	70.79	54.84	375.89	751.78	1503.56
36	63.10	48.87	298.58	597.16	1194.32
35	56.23	43.56	237.17	474.34	948.68
34	50.12	38.82	188.39	376.78	753.57
33	44.67	34.60	149.64	299.29	598.58
32	39.81	30.84	118.87	237.73	475.47
31	35.48	27.48	94.42	188.84	377.68
30	31.62	24.49	75.00	150.00	300.00

Using this table it is a straightforward procedure to work out the required setting of the limiter thresholds for the system.

- ✓ First, check the RMS power rating of the speaker system, and its impedance.
- ✓ Look up this value in the table above, using the closest value below the rated power of the speaker system. Note the corresponding 'dB' value.
- ✓ Check the gain of your amplifier, which needs to be in 'dB'.
- ✓ Subtract FROM this gain figure that obtained from the table to find the required absolute setting for the limiter thresholds.

Note that, for safety, always set the limiter threshold 1 or 2 dB below the maximum allowable worked out using the above method.



## The Funktion One Approach

Limiter settings are dependent on through gain, sensitivity and the loudspeaker's power handling ability. The most important thing is that the amplifier should never be allowed to run into continuous clip. Clipping squares off the output waveform of the amp, sending distortion in the form of harmonics through to the voice coil, this creates heat which, if it continues, will burn out the voice coil. Effectively a small amp in clip is more likely to damage a speaker than a large amp running cleanly. To avoid this, the limiters should be set at least 1 dB below the amplifier's input sensitivity.

Of course setting limiters in this way does not make allowance for the fact that the amplifiers' power capability may exceed that which the speaker can handle. A suitable starting point would be to set the Bass limiters in the above way with each successive higher band being reduced by a further 2dB (assuming equal input sensitivities and gains). Therefore on a Resolution 5 four-way system, the HF limiters would end up being set at least 6dB safer than the Bass (of course input sensitivity and gain have to be taken into account). The other factor at play here is how many drivers are connected to each amplifier channel. The lower the impedance of the load, the earlier the amplifier will clip and therefore limiters should be set for the maximum number of drivers that will be driven per channel (the lowest impedance).

This conversion table may be useful:

RMS Volts	dBu/dBv	dBV
2.47	+10	+8
1.95	+8	+6
1.56	+6	+4
1.24	+4	+2
0.98	+2	0
0.78	0	-2
0.62	-2	-4
0.49	-4	-6
0.39	-6	-8
0.31	-8	-10
0.25	-10	-12

**REMEMBER:** The primary purpose of crossover band limiting is to protect the system from overdriving, sudden and unexpected high level signals and occasional larger than normal transients. It is not intended to be used instead of compressors and therefore limit lights should not be flashing or on all the time. If a system is limiting heavily, audio quality and drive units will suffer. However, if set up carefully they can be used to ensure the system stays in its comfort zone, the frequency spectrum remains reasonably balanced and the maximum system level is controlled for aesthetic or environmental reasons.

### Balanced sound "On The Limit"

Here are a couple of normal scenarios.

1. You've got your mix set up and "in the pocket" then the singer gets a bit excited and shouts "Hello (insert your town here)! Are we all having a good time??!" His vocal compressor is set at a low ratio (or there isn't one) and you're not quick enough on the fader to catch the sudden burst of level. Happily your system limiters are set a couple of dB before the clip point of the amps in accordance with the power handling of the drivers and the amps don't clip.
2. A sudden burst of feedback from a vocal mic too near a side fill and the same thing happens.



3. An inexperienced guest engineer loses control of the mix and ends up running too loud, the limiters start flashing and we ask him to back off a bit, he's surprised that it actually starts to sound louder when the masters are pulled down a little and the limiters stop pumping.

In all these cases the limiters are set for system safety and nothing gets broken, all good but what does the system actually sound like and how loud is it when the limiters come into play?

Mid and HF horns are usually more efficient than low mid and bass drivers. Of course they handle less power but you can often get a situation where, if everything is just set for safety, the system is capable of being driven into a state of imbalance where it sounds bad and can even be way too loud for the venue and the safety of the people in it. Bass speakers these days can handle a massive amount of power (as long as it's clean) so large amps are used and limiters set to stop clip from occurring. Mid and high limiters are set progressively tighter in respect to the drivers lesser power handling. It's still a good idea to use a large amp though. Transient spikes, totally valid to the music like the hit of the snare or cymbal crashes can get past the limiters and this is good because the dynamics and excitement of the music are preserved and these transients are not long enough to overpower the driver as long as they're not clipping.

So what happens as the system comes up to full power?

Often the bass will limit first, then as the system is driven harder the low mid starts to limit, the high-mids are still going strong as are the highs. If the bass limits 4 dB before the mid highs this is effectively the same as turning up the mid highs by 4dB, the balance of the system is completely wrong and all the hard work of tuning and sound check is wasted. The thing to do here is to tighten the limiters still further so that the mids and highs start to limit at around the same point as the bass. This way the frequency content of the music will be maintained when in the limiters; the mids stay at a level where they still relate to the low end. The settings for this will be different for live and club systems; you will want to leave a bit more headroom for the dynamics of live music. In a night club there may be noise restrictions or the owner may have an idea of how loud he wants the system to go. The principle is the same. In both cases run the system up to the required maximum level, reduce the limiters so that the limit lights are flashing then open up a dB or so to account for when the room is warm and full of people, come back later when the venue is running and fine tune if needed. Above all, lock the system to safeguard against tampering! Your system is now not only safe against damage, its also safe against being driven out of balance and sounding really bad.

Digital Crossovers

Another point is that digital crossovers need to be driven at the correct level to ensure maximum use of the resolution available because at low input drive levels fewer bits are used. Signal should be clearly visible on the input meters with the -6dB light flashing to get the best from the converters. Because Funktion One equipment is so intrinsically efficient (high conversion of amplifier energy into acoustic energy) we often need to reduce amplifier gain to achieve this. Signal to noise ratio will also be improved. A suitable amplifier input sensitivity to achieve this would be +10 dBu. If amplifier gain is reduced then limiters will need to be adjusted accordingly.



**Warning**

If the amp front panel controls are used to reduce gain and the limiters are reset to suit then great care must be taken not to turn the front panel gain control up again without re-adjusting the limiters. Crew or other operators must be made aware of this. In a 'dry-hire' environment it is probably not advisable to send a system out like this without locking the amplifier level controls to avoid unauthorised adjustment. If this isn't possible, then the sonic advantages may have to be forgone.

Crossover Filter Slopes

It should also be noted that the turnover frequency displayed on the screen is the -3dB point for all types except Linkwitz-Riley where the -6dB point is shown. If the -6dB point is to be used for the Bessel or Butterworth filter, take the required crossover frequency, multiply this by the appropriate factor from the following table and then select the closest available frequency on the display.

Filter Type	High pass factors	Low pass factors
Bessel 12dB/Oct.	1.45	0.69
Butterworth 12dB/Oct.	1.31	0.76



Bessel 18dB/Oct.	1.37	0.73
Butterworth 18dB/Oct.	1.19	0.84
Bessel 24dB/Oct.	1.35	0.74
Butterworth 24dB/Oct.	1.15	0.87
Bessel 48dB/Oct.	1.39	0.72
Butterworth 48dB/Oct.	1.08	0.93

Please note that unlike conventional analogue crossovers, crossover points and slopes are set with absolute accuracy since component tolerance problems do not occur.

Please see page 17 for details of how to adjust the high and low pass crossover filter settings.

## Time Alignment

A further advantage of the **4 Series** over conventional products is the provision of an independently adjustable delay section for each output. This allows the true arrival time from multiple drivers to precisely aligned rather than relying on the compromise 'phase adjust' approach. Delay time is adjustable in 0.3µS steps (0.1mm). Please see page 16 for details of how to adjust the delay times.

To convert from units of time (i.e. milliseconds) to units of distance use the following formula:  
1 millisecond = 343mm (1.126ft) @ 20°C (68°F)

To calculate time delay for a known distance, use:

$$\text{Time delay} = \frac{\text{Distance in meters}}{20.06 \times \sqrt{273 + ^\circ\text{C}}}$$

where °C is the temperature in °C.

To simplify this equation at 20°C.

Delay time in milliseconds =  
(Distance in meters x 2.192) or (Distance in feet x 0.955)

Note: Centigrade = (Fahrenheit – 32) x 0.5555.



# Parametric Filter Types and Their Uses

A wide selection of filter types has been made available under the PEQ section when editing input or output filters. Scrolling through the various filter types is achieved by repeated presses of the **ENTER** key. Note that this will only change filter types if the filter is **BYPASSED** or the **GAIN** set to 0dB. Bypassing the filter, then changing types using the **ENTER** key will automatically set the gain back to 0dB.

Each filter type will be explained in turn in the following section.

## Standard Parametric EQ

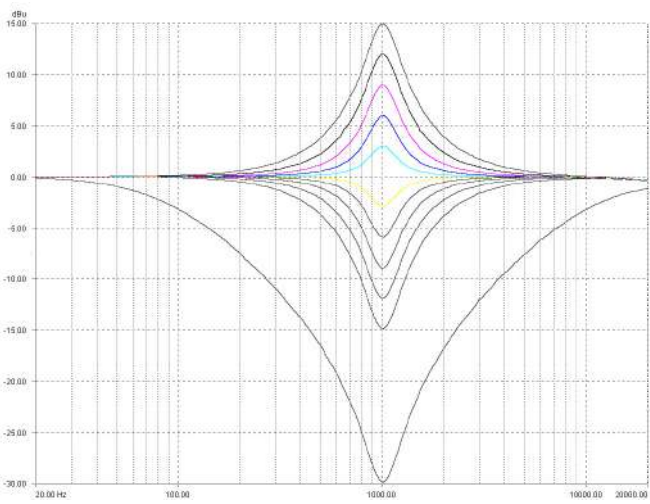

InA Input A PEQ:1<>  
1k00Hz Q=3.0 0.0dB

The standard parametric band has adjustable frequency, 'Q' (or Bandwidth) and Gain controls. These affect a range of frequencies symmetrically about the centre frequency as shown in the graph.

Various levels of cut and boost are shown to the left, along with various 'Q' settings (gain boosts only are shown below). Remember that 'Q' is 1/Bandwidth, so the higher the 'Q', the lower the Bandwidth, and the smaller the range of frequencies affected.

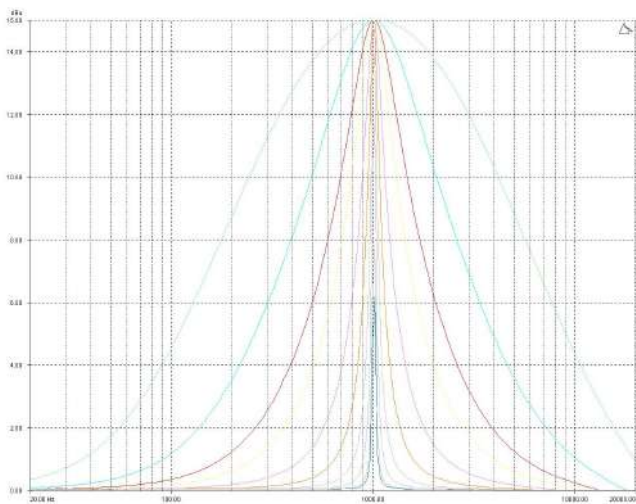

Shelving EQ (High Shelf shown)

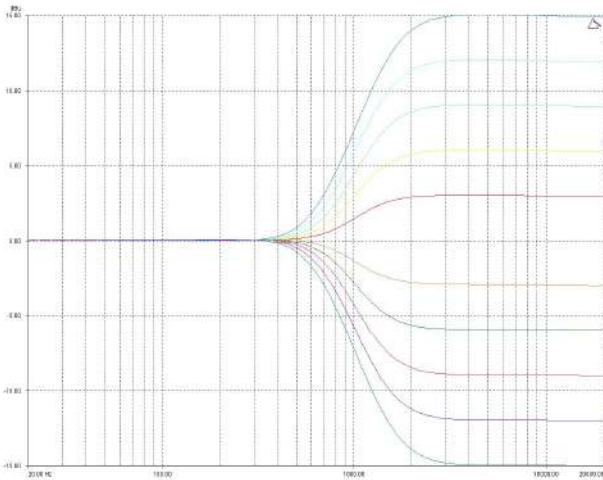

InA Input A HSF:1-<::  
1k00Hz Q=3.0 0.0dB

Remember – to change filter types, press **BYPASS** to bypass the filter, and then use **ENTER** to select the filter type.

The shelving EQ has adjustable frequency, 'Q' (or Bandwidth) and Gain controls. These affect a range of frequencies from the turnover frequency as shown in the graph. For a high shelf, frequencies above the turnover frequency will be affected. For a low shelf, frequencies below the turnover frequency will be affected.

Various levels of cut and boost are shown to the left, along with various 'Q' settings (gain boosts only are show below).

Remember that 'Q' is 1/Bandwidth, so the higher the 'Q', the lower the Bandwidth, and the smaller the range of frequencies affected.

Note that 'Q' settings above 0.75 will result in slight overshoot in the filter response (as seen at the highest setting to the right). This is normal behaviour and does not indicate instability.

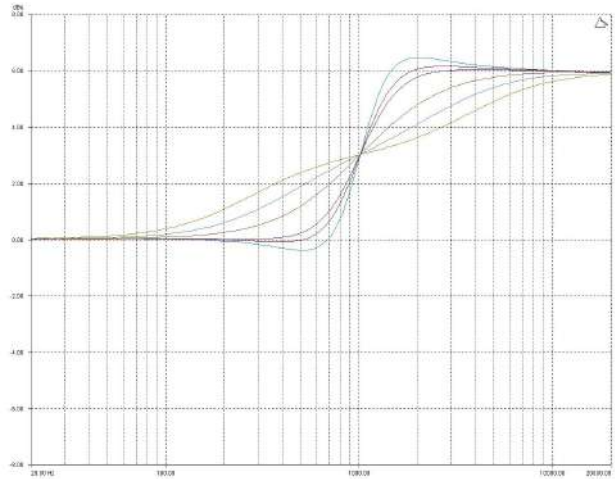

Creating a Flat-topped EQ Response

To create a flat-topped EQ filter response such as that shown to the left, use two EQ bands, BOTH configured as low shelves. For an overall BOOST, set the Lower frequency filter to BOOST the desired amount, and the Upper frequency filter to CUT by the same amount.

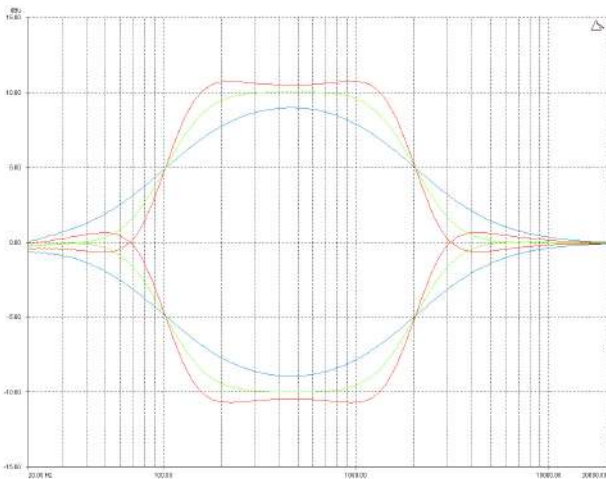

This example shows one filter at 100Hz and the other at 2kHz, with the 100Hz filter at -10dB, and the 2kHz filter at +10dB. Varying the 'Q' affects the slope of the response – values above 0.75 will cause overshoot as shown.

Assymetrical responses may be achieved by adjusting the 'Q' of each filter independently.



Low/High Pass Variable 'Q' Filter (Low Pass shown)

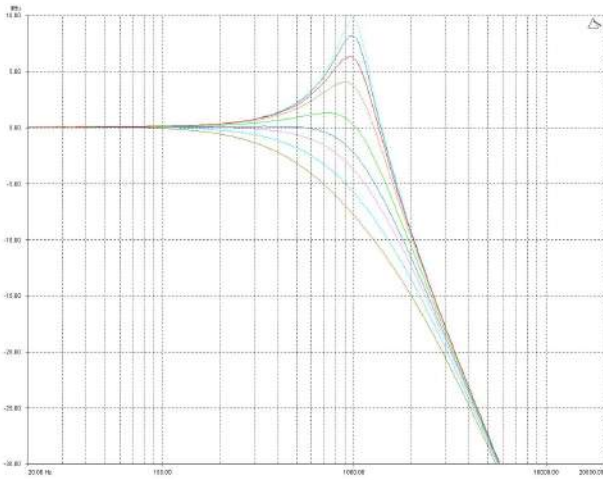

InA Input A LPF:1~~\  
1k00Hz Q=3.0 LPF VarQ

Remember – to change filter types, press **BYPASS** to bypass the filter, and then use **ENTER** to select the filter type.

The low and high pass variable 'Q' filters have adjustable frequency and 'Q' (or Bandwidth) controls. The 'Q' control adjust the damping of the filter, so that low 'Q' settings show less overshoot at the turnover frequency, but also slower roll-off.

Remember that 'Q' is 1/Bandwidth, so the higher the 'Q', the lower the Bandwidth, and the smaller the range of frequencies affected. The filter is primarily 12dB/Octave, but in achieving this sort of roll-off with a high 'Q' value will result in quite a large overshoot in level at the turnover frequency. This type of filter is often also called a resonant filter.



## Specifications

Inputs: 2/4 electronically balanced ◆

Impedance: > 10k ohms.

CMRR : >65dB 50Hz - 10kHz.

Outputs: 4/6/8 electronically balanced ◆

Source Imp: < 60ohms

Min. Load: 600ohm

Max. Level: +20dBm into 600 ohm

Frequency Resp.:  $\pm 1/2$ dB 20Hz-20kHz

-3dB @ 32kHz

Dyn. Range: >116dB 20Hz-20k unwt'd

Distortion: < .02%@1kHz, +18dBm

Maximum Delay: 650 mS

Min Step Size: 0.3  $\mu$ S

Input Gain: +6dB to -40dB in 0.1dB steps

Output Gain: +15dB to -40dB in 0.1dB steps and mute

### Parametric Equalisation

8 per Input / 9 Sections per Output

Filter Gain: +15dB to -30dB in 0.1dB steps.

Freq. Range: 19.7Hz - 32kHz, 1/36 octave steps.

Filter Q / BW: 0.4 to 128 / 2.5 to 0.008

(Sections switched to shelving response)

Low frequency: 19.2Hz - 1kHz

High frequency: 1kHz - 32kHz

Shelf gains:  $\pm 15$ dB in 0.1dB steps.

### High and Lowpass Filters

Filters: 1 of each per output.

Freq. Range HPF: 10Hz - 16kHz

1/36 octave steps.

Freq. Range LPF: 35Hz - 22kHz

1/36 octave steps.

Responses:

1<sup>st</sup> Order 6dB/Oct.

Bessel/Butterworth/Linkwitz-Riley 12-24-48dB/Oct.

Bessel/Butterworth 18dB/Oct.

### Limiters

Program Limiter:

Threshold: +22dBu to -10dBu

Attack time: 0.3 to 90 milliseconds

Release time: 2/4/8/16/32 x Attack time

"D-Max" Limiter:

Attack Time: -60 $\mu$ S

Release Time: Slow/Medium/Fast

Display: 2 x 24 Character LCD

Input meter: 2 x 6 point, -24dB to digital clip.

Output meter: 8 x 6 point, -24dB to +4dB into limit.

### Connectors

Inputs: 3 pin female XLR

Outputs: 3 pin male XLR.

External: 9 pin DEE connector (RS232)

RS485: 3 pin male XLR (out) 3 pin male XLR (in)

Power: 3 pin IEC

Power: 60 to 250V  $\pm 15\%$  @ 50/60Hz.

Consumption: < 30 watts.

Weight: 3.3kg. Net (4.7kg. Shipping)

Size: 1.75"(1U) x 19" x 11.8"

(44 x 482 x 300mm) excluding connectors

◆ Transformer options available

Due to continuing product improvement the above specifications are subject to change.

Latency: 1.5mS (analogue in – analogue out @ 96kHz)



## Warranty

---

This product is warranted against defects in components and workmanship only, for a period of five years from the date of shipment to the end user. During the warranty period, XTA will, at its discretion, either repair or replace products that prove to be defective, provided that the product is returned, shipping prepaid, to an authorised XTA service facility.

Defects caused by unauthorised modifications, misuse, negligence, act of God or accident, or any use of this product that is not in accordance with the instructions provided by XTA, are not covered by this warranty.

This warranty is exclusive and no other warranty is expressed or implied. XTA is not liable for consequential damages.

## Options and Accessories (available from XTA or via Funktion One)

---

Part Number	Part Description
ITX-428	Transformer balanced inputs (factory fitted only)
OTX-428	Transformer balanced outputs (factory fitted only)
INT-485	RS232 to RS485 converter kit with 9 pin 'D' type to XLR male adaptor cable (from PC to DP428)
USB-485	USB-Serial-RS485 converter with special K2-ADE RS232-485 Converter

XTA has a range of tried and tested interfaces, including USB and wireless solutions, all of which are listed in the XTA Interface Guide, available from their website.



---

**A**

- Accessories · 50
- AES Diagnostics** · 36
- AES Interface · 35
- AES Menu · 25
- Attack Times · 39

---

**B**

- Base Delay · 17

---

**C**

- Clip Limiter · 20, 40
- Crossover Menu · 25

---

**D**

- Delay · 17
  - Look Ahead · 40
- Digital In & Out · 35
- D-Max · 40

---

**E**

- Editing
  - Base Delay · 17
  - High Pass Filter · 19
  - Input Gain · 17
  - Limiters · 20
  - Low Pass Filter · 19
  - Output Delay · 18
  - Output Gain · 18
  - Parametric EQ · 17, 19
  - Polarity · 18

---

**F**

- Features · 8
- Flat Topped EQ · 47
- Free Assign · 16
- Front Panel · 10

---

**G**

- Ganging Inputs · 21
- Ganging Outputs · 21
- Global Memory Menu · 25
- Graphic Menu · 25

---

**H**

- High Pass Filter · 19

---

**I**

- Input Gain · 17
- Input Section Menu · 25
- Interface
  - RS232 · 29
  - RS485 · 33
  - USB · 29
- Interface Menu · 25

---

**L**

- Limiter
  - Overshoot Prevention · 41
- Limiter Threshold · 42
- Limiters · 39
- Load New Software · 30
- Lockouts · 37
- Look Ahead · 40
- Look Ahead Delay · 40
- Low Pass Filter · 19

---

**M**

- Master Password · 38
- Memory Structure · 26
- Menus
  - Details · 25
  - Quick Ref. · 23
  - Shortcuts · 24

---

**O**

- Options · 50
- Output Delay · 18
- Output Gain · 18

---

**P**

- Parametric EQ · 17, 19
- Password Override · 38
- Passwords · 37
- Polarity · 18
- Program Limiter · 20

---

**Q**

- Quick Setup · 12

---

**R**

- Rear Panel · 11
- Release Times · 39
- Resonant Filter · 48
- Routing · 16
  - Basic · 13



Free Assign · 16  
 Presets · 13  
 RS232 Interface · 29  
 RS485 Interface · 33

---

**S**

Security · 37  
 Security Menu · 25  
 Shadow IDs · 32  
 Shelving EQ · 47  
 Shipping · 7  
 Sidechain  
   Delay · 40  
 Specifications · 49  
 Standard Parametric · 46  
 Start-up · 12  
 System Menu · 25

---

**U**

Unlocking · 38  
 Unpacking · 7  
 Updating Software · 30  
 Upgrading · 30  
 USB Interface · 29

---

**V**

Vari-Q · 48

---

**W**

Waranty · 50

